

Uni-directional

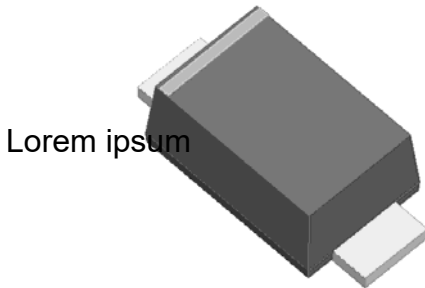

Lorem ipsum

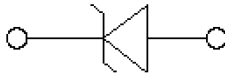

Bi-directional



■ **FEATURES**

- For surface mounted applications
- Low-profile package
- Ideal for automated placement
- Available in Unidirectional and Bidirectional
- 400 W peak pulse power capability with a 10/1000 μ s waveform
- Low incremental surge resistance, excellent clamping capability
- Very fast response time
- High temperature soldering guaranteed: 260 °C/10 s at terminals
- Meets MSL level 1
- Component in accordance to RoHS

■ **TYPICAL APPLICATIONS**

Use in sensitive electronics protection against voltage transients induced by inductive load switching and lighting on ICs, MOSFET, signal lines of sensor units for consumer, computer, industrial, telecommunication.

■ **MECHANICAL DATA**

- **Package:** SOD-123FL
Molding compound meets UL 94 V-0 flammability rating, RoHS-compliant, halogen-free
- **Terminals:** Tin plated leads, solderable per J-STD-002 and JESD22-B102
- **Polarity:** For uni-directional types the band denotes cathode end, no marking on bi-directional types

■ **MAXIMUM RATINGS** ($T_a=25^\circ\text{C}$ Unless otherwise specified)

PARAMETER	SYMBOL	UNIT	Conditions	Max
Peak power dissipation(1) (2) (Fig.1)	P_{PPM}	W	with a 10/1000us waveform	400
Peak pulse current(1)	I_{PPM}	A	with a 10/1000us waveform	(See Next Table)
Power dissipation, on infinite heat sink	P_D	W	$T_L=75^\circ\text{C}$	0.8
Peak forward surge current, 8.3 ms single half sine-wave unidirectional only (3)	I_{FSM}	A		30
Operating junction and storage temperature range	T_J, T_{STG}	$^\circ\text{C}$		-55 to +150
Thermal resistance	$R_{\theta JL}$	$^\circ\text{C/W}$	Between junction and lead	26
	$R_{\theta JA}$		Between junction and Ambient	300
	$R_{\theta JC}$		Between junction and Curve	40

Notes:

- (1). Non repetitive current pulse. per Fig2 and derated above $T_A=25^\circ\text{C}$ per Fig3.
- (2). $T_L=30^\circ\text{C}$ unless otherwise noted, $V_F \leq 1.25\text{V}@200\text{mA}$.
- (3). Measured on 8.3 ms single half sine-wave or equivalent square wave, duty cycle = 4 pulses per minute maximum

PACKAGING INFORMATION

PREFERRED P/N	PACKING CODE	UNIT WEIGHT(g)	MINIMUM PACKAGE(pcs)	INNER BOX QUANTITY(pcs)	OUTER CARTON QUANTITY(pcs)	DELIVERY MODE
SM4F SERIES	F1	0.0167	3000	30000	120000	7" reel
SM4F SERIES	F2	0.0167	10000	20000	160000	13" reel

ELECTRICAL CHARACTERISTICS (T_a=25°C Unless otherwise specified)

Part Number		Marking		Breakdown Voltage V _{BR} @I _T			Maximum Reverse Leakage I _R @ V _{RWM} (μA)	Working Peak Reverse Voltage V _{RWM} (V)	Maximum Reverse Surge Current I _{PP} ⁽²⁾ (A)	Maximum Clamping Voltage V _c @ I _{PP} (V)
(Uni)	(Bi)	(Uni)	(Bi)	Min(V)	Max (V)	I _T ⁽¹⁾ (mA)				
SM4F5.0A	SM4F5.0CA	F5.0A	F5.0CA	6.40	7.07	10	800	5.0	43.38	9.2
SM4F6.0A	SM4F6.0CA	F6.0A	F6.0CA	6.67	7.37	10	800	6.0	38.83	10.3
SM4F6.5A	SM4F6.5CA	F6.5A	F6.5CA	7.22	7.98	10	500	6.5	35.71	11.2
SM4F7.0A	SM4F7.0CA	F7.0A	F7.0CA	7.78	8.60	10	200	7.0	33.33	12.0
SM4F7.5A	SM4F7.5CA	F7.5A	F7.5CA	8.33	9.21	1	100	7.5	31.01	12.9
SM4F8.0A	SM4F8.0CA	F8.0A	F8.0CA	8.89	9.83	1	50	8.0	29.41	13.6
SM4F8.5A	SM4F8.5CA	F8.5A	F8.5CA	9.44	10.40	1	10	8.5	27.78	14.4
SM4F9.0A	SM4F9.0CA	F9.0A	F9.0CA	10.00	11.10	1	5	9.0	25.97	15.4
SM4F10A	SM4F10CA	F10A	F10CA	11.10	12.30	1	2.5	10.0	23.52	17.0
SM4F11A	SM4F11CA	F11A	F11CA	12.20	13.50	1	2.5	11.0	21.98	18.2
SM4F12A	SM4F12CA	F12A	F12CA	13.30	14.70	1	2.5	12.0	20.1	19.9
SM4F13A	SM4F13CA	F13A	F13CA	14.40	15.90	1	1.0	13.0	18.6	20.0
SM4F14A	SM4F14CA	F14A	F14CA	15.60	17.20	1	1.0	14.0	17.24	23.2
SM4F15A	SM4F15CA	F15A	F15CA	16.70	18.50	1	1.0	15.0	16.4	24.4
SM4F16A	SM4F16CA	F16A	F16CA	17.80	19.70	1	1.0	16.0	15.38	26.0
SM4F17A	SM4F17CA	F17A	F17CA	18.90	20.90	1	1.0	17.0	14.5	27.6
SM4F18A	SM4F18CA	F18A	F18CA	20.00	22.10	1	1.0	18.0	13.7	29.2
SM4F19A	SM4F19CA	F19A	F19CA	21.10	23.30	1	1.0	19.0	13.08	30.6
SM4F20A	SM4F20CA	F20A	F20CA	22.20	24.50	1	1.0	20.0	12.34	32.4
SM4F22A	SM4F22CA	F22A	F22CA	24.40	26.90	1	1.0	22.0	11.26	35.5
SM4F24A	SM4F24CA	F24A	F24CA	26.70	29.50	1	1.0	24.0	10.28	38.9
SM4F26A	SM4F26CA	F26A	F26CA	28.90	31.90	1	1.0	26.0	9.5	42.1
SM4F28A	SM4F28CA	F28A	F28CA	31.10	34.40	1	1.0	28.0	8.82	45.4

Part Number		Marking		Breakdown Voltage $V_{BR}@I_T$			Maximum Reverse Leakage $I_R @ V_{RWM}$ (μA)	Working Peak Reverse Voltage V_{RWM} (V)	Maximum Reverse Surge Current $I_{PP}^{(2)}$ (A)	Maximum Clamping Voltage $V_c @ I_{PP}$ (V)
(Uni)	(Bi)	(Uni)	(Bi)	Min(V)	Max (V)	$I_T^{(1)}$ (mA)				
SM4F30A	SM4F30CA	F30A	F30CA	33.30	36.80	1	1.0	30.0	8.26	48.4
SM4F33A	SM4F33CA	F33A	F33CA	36.70	40.60	1	1.0	33.0	7.5	53.3
SM4F36A	SM4F36CA	F36A	F36CA	40.00	44.20	1	1.0	36.0	6.88	58.1
SM4F40A	SM4F40CA	F40A	F40CA	44.40	49.10	1	1.0	40.0	6.2	64.5
SM4F43A	SM4F43CA	F43A	F43CA	47.80	52.80	1	1.0	43.0	5.76	69.4
SM4F45A	SM4F45CA	F45A	F45CA	50.00	55.30	1	1.0	45.0	5.5	72.7
SM4F48A	/	F48A	/	53.30	58.90	1	1.0	48.0	5.16	77.4
SM4F51A	/	F51A	/	56.70	62.70	1	1.0	51.0	4.86	82.4
SM4F54A	/	F54A	/	60.00	66.30	1	1.0	54.0	4.6	87.1
SM4F58A	/	F58A	/	64.40	71.20	1	1.0	58.0	4.28	93.6
SM4F60A	/	F60A	/	66.70	73.70	1	1.0	60.0	4.14	96.8
SM4F64A	/	F64A	/	71.10	78.60	1	1.0	64.0	3.88	103.0
SM4F70A	/	F70A	/	77.80	86.00	1	1.0	70.0	3.54	113.0
SM4F75A	/	F75A	/	83.30	92.10	1	1.0	75.0	3.3	121.0
SM4F78A	/	F78A	/	86.70	95.80	1	1.0	78.0	3.18	126.0
SM4F80A	/	F80A	/	88.80	97.60	1	1.0	80.0	3.1	129.0
SM4F85A	/	F85A	/	94.40	104.00	1	1.0	85.0	2.92	137.0
SM4F90A	/	F90A	/	100.00	111.00	1	1.0	90.0	2.74	146.0
SM4F100A	/	F100A	/	111.00	123.00	1	1.0	100.0	2.46	162.0

Notes:

- (1) $t_p \leq 50ms$ Pulse test: $t_p \leq 50ms$.
- (2) Surge current waveform per Fig. 2 and derated per Fig.3.

CHARACTERISTICS (TYPICAL)

FIG1: Peak Pulse Power Rating Curve

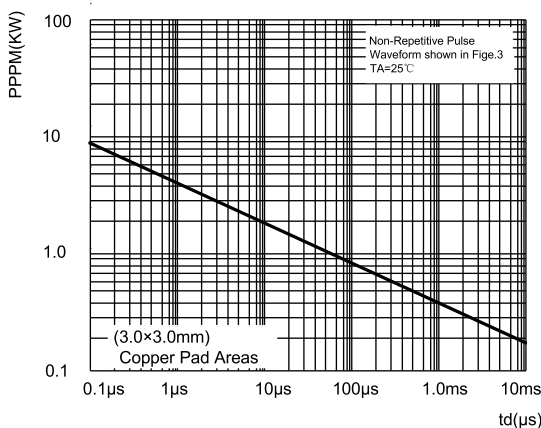
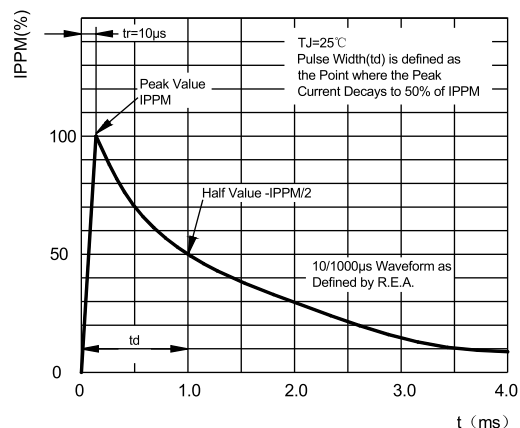
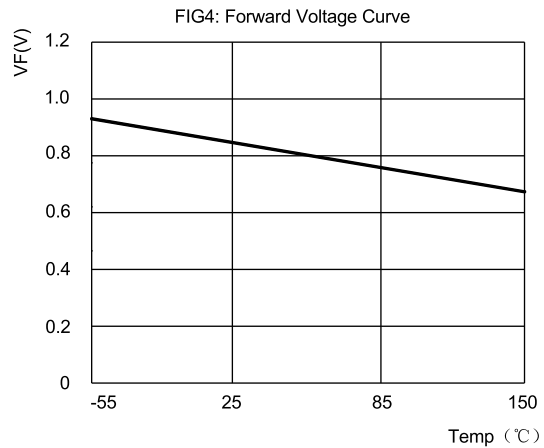
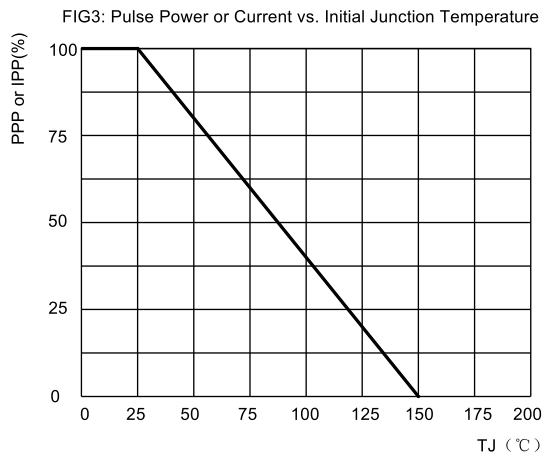

FIG2: Pulse Waveform



■ **CHARACTERISTICS (TYPICAL)**



■ **OUTLINE DIMENSIONS**

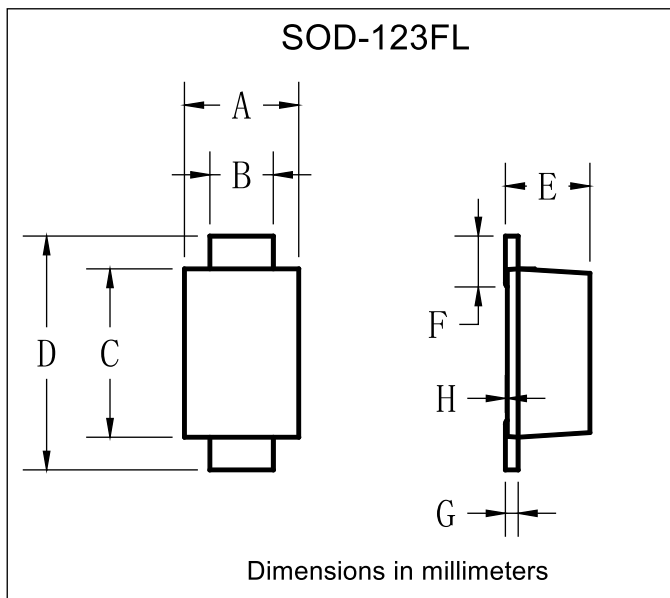

SOD-123FL		
Dim	Min	Max
A	1.60	1.90
B	0.90	1.10
C	2.55	2.85
D	3.60	3.90
E	1.00	1.20
F	0.40	0.90
G	0.10	0.25
H	0.02	0.05

■ **SUGGESTED PAD LAYOUT**

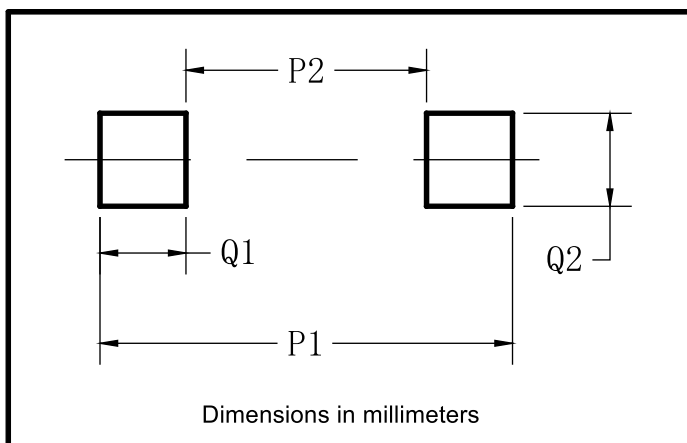

SOD-123FL	
Dim	Millimeters
P1	3.90
P2	1.90
Q1	1.00
Q2	1.50