

The normal type N series of Metal Oxide Varistor (MOV) are radial lead varistors (also known as Voltage Dependent Resistors or VDRs) that are designed to be used continuously across AC line primary or DC circuit for transient voltage and surge suppression.

Operating Temperature -40°C~+125°C

RECOGNITION : made for RFE by UL shop Joyin



Agency	File Number	Monogram
UL/cUL	E325508	
VDE	Certificate No. 005937	
CQC	CQC07001019159 /9161/9162/9163/9164	

CHARACTERISTICS & RATINGS

Part Number	Varistor Voltage at 0.1mA		Maximum Allowable Voltage		Maximum Clamping Voltage		Withstanding Surge Current (8/20µs)	Nominal Discharge Current (8/20µs)	Rated Wattage	Energy (10/1000µs)
	DC (V)	Tolerance	AC rms (V)	DC (V)	V@ ic (V)	ic (A)				
JVT05N180M65***	18	20%	11	14	40	1	100	0.1	0.01	0.6
JVT05N220L65***	22	15%	14	18	48					0.7
JVT05N270K65***	27	10%	17	22	60					0.9
JVT05N330K65***	33		20	26	73					1.1
JVT05N390K65***	39		25	31	86					1.2
JVT05N470K65***	47		30	38	104					1.5
JVT05N560K65***	56		35	45	123					1.8
JVT05N680K65***	68		40	56	150					2.1
JVT05N820K65***	82		50	65	145					2.8
JVT05N101K65***	100		60	85	175					3.5
JVT05N121K65***	120		75	100	210	4				
JVT05N151K65***	150		95	125	260	5.5				
JVT05N181K65***	180	115	150	320	6.5					
JVT05N201K65***	200	130	170	355	7.1					
JVT05N221K65***	220	140	180	380	7.8					
JVT05N241K65***	240	150	200	415	8.4					
JVT05N271K65***	270	175	225	475	9.9					
JVT5N301K65***	300	195	250	525	5	400	0.1	0.1	10.5	
JVT05N331K65***	330	210	275	575					11.5	
JVT05N361K65***	360	230	300	620					13	
JVT05N391K65***	390	250	320	675					15	
JVT05N431K65***	430	275	350	745					16.5	
JVT05N471K65***	470	300	385	810					17.5	
JVT05N511K65***	510	320	418	880					18.5	
JVT05N561K65***	560	350	460	940					19.5	
JVT05N621K65***	620	385	505	1050					20.5	
JVT05N681K65***	680	420	560	1150					21.5	
JVT05N751K65***	750	460	615	1290	22.5					

*** Replace with Lead & Packaging code

■ **5mm PULSE LIFETIME RATINGS**

■ **5mm V-I CHARACTERISTIC CURVE**

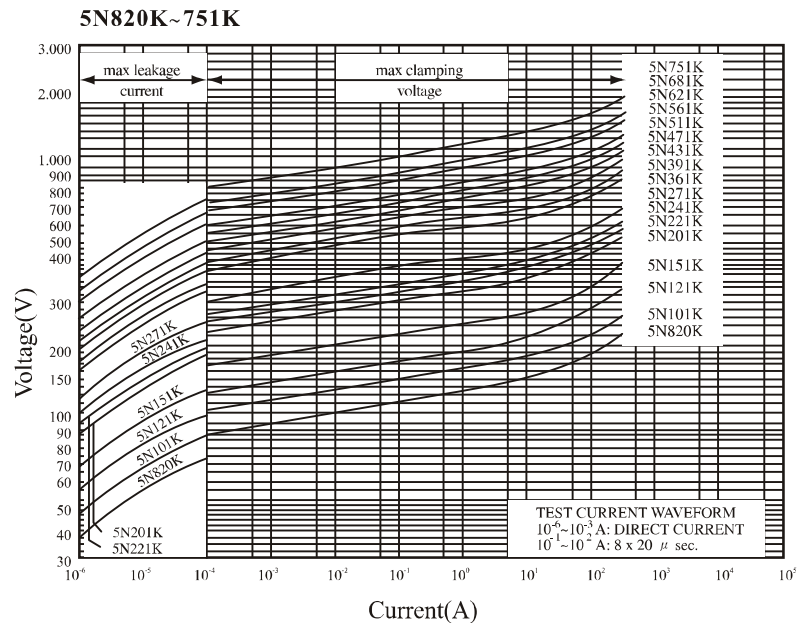
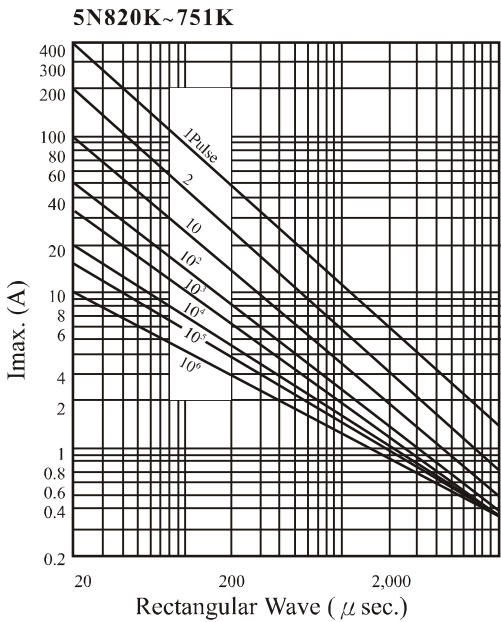
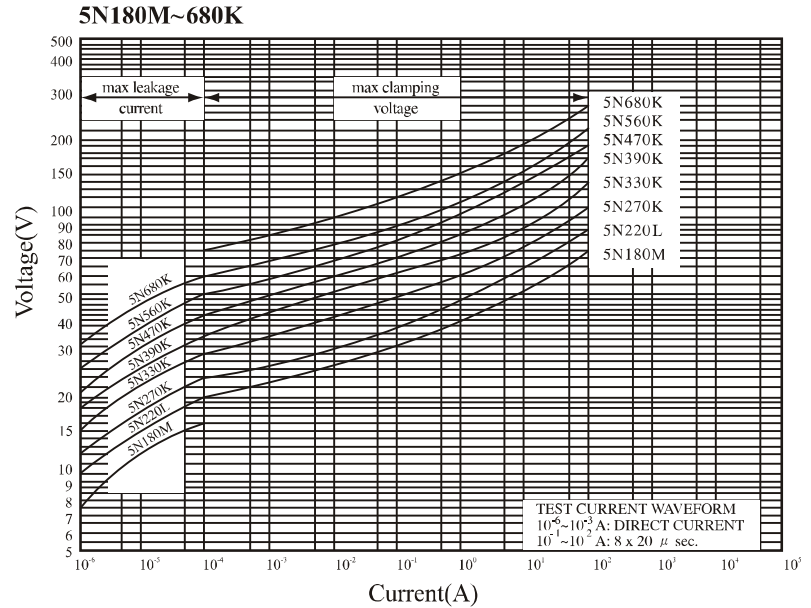
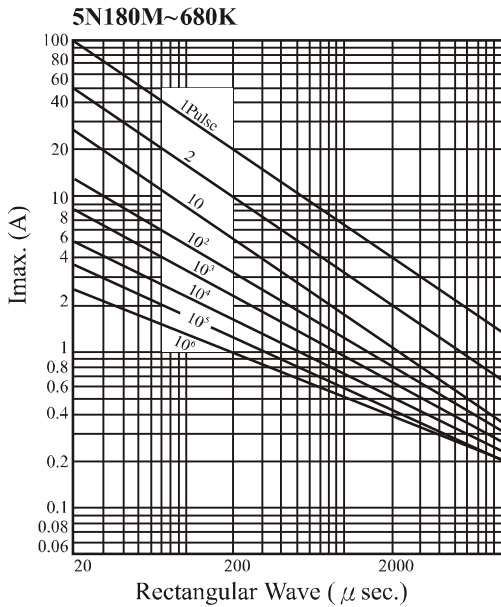

■ **CURRENT - VOLTAGE CHARACTERISTICS**

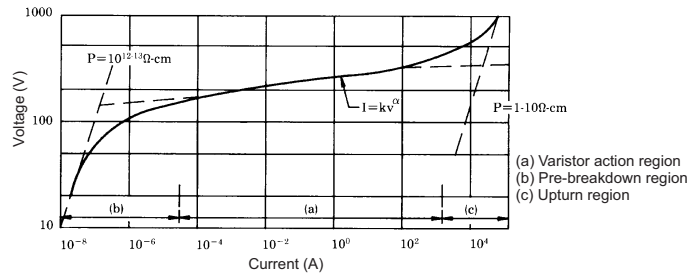

Operating & Storage temperature Range : -40°C to +85°C
Temperature Coefficient of Voltage : 0~0.05% / °C max.

■ PART NUMBER EXAMPLE

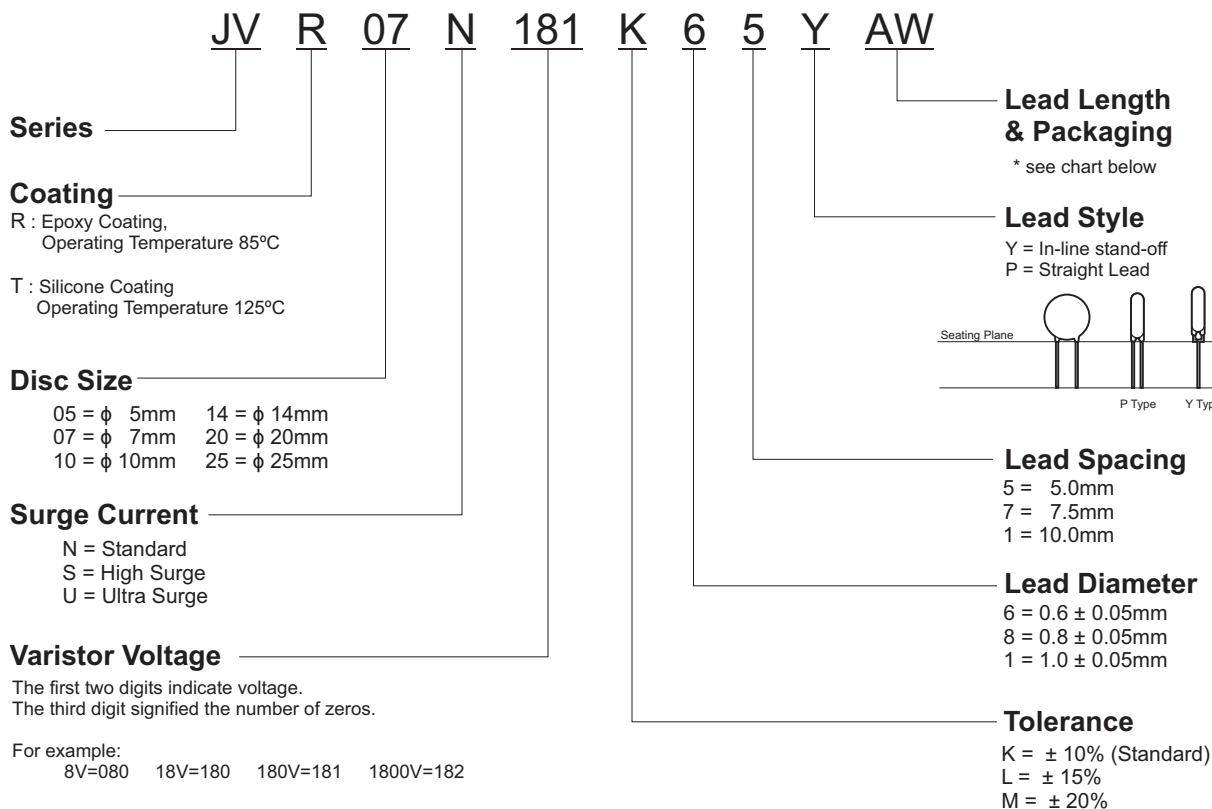

■ LEAD LENGTH & PACKAGING

Stand-off Formed (Y Type)

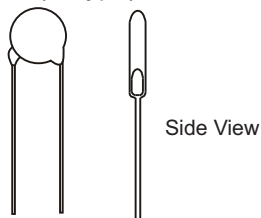

Straight Lead (P Type)

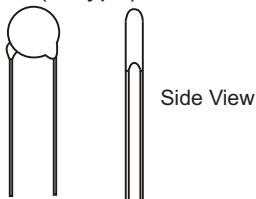

Lead Type	Code	Dimension	Package
Y Type Leads	50	L = 5 ± 1 mm	Bulk
	U4	L = 24mm min.	Bulk
	AW	H ₀ = 16mm	Ammo
	RW	H ₀ = 16mm	Reel
P Type Leads	50	L = 5 ± 1 mm	Bulk
	U5	L = 25mm min.	Bulk
	AY	H ₀ = 20mm	Ammo
	RY	H ₀ = 20mm	Reel

* H₀ see the drawing on page 5

LEAD STYLES & DIMENSIONS (mm)

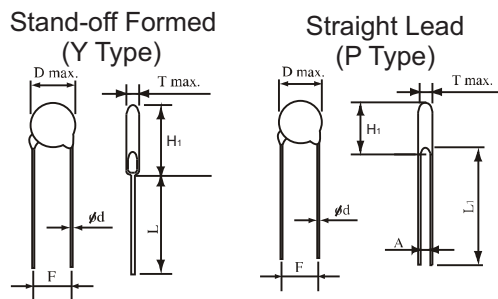

Diameter	5mm	7mm	10mm	14mm	20mm
D max	7.5	9.0	12.5	16.5	23.0
d ± 0.05	0.6	0.6	0.8	0.8	1.0
F ± 1.0	5.0	5.0	7.5	7.5	10.0
H max.	11.0	13.0	18/*19	22/*23	28/*29
L1 max.	25.0	25.0	25.0	25.0	25.0
L min.	24.0	24.0	24.0	24.0	24.0

* Just for 182K

Table of T & H₁ max, A ± 0.8

Diameter	5mm			7mm			10mm			14mm			20mm		
	T	A	H ₁	T	A	H ₁	T	A	H ₁	T	A	H ₁	T	A	H ₁
180M	4.5	0.8	10.5	4.5	0.8	12	4.9	0.8	15.5	5	0.9	19.5	---	---	---
220M/L	4.5	0.9	10.5	4.5	0.9	12	4.9	0.9	15.5	5	1	19.5	5.3	1	26.5
270M/K	4.7	0.9	10.5	4.7	0.9	12	5.1	0.9	15.5	5.2	1.1	19.5	5.4	1.1	26.5
330M/K	4.7	1	10.5	4.7	1	12	5.1	1	15.5	5.2	1.2	19.5	5.4	1.2	26.5
390L/K	4.7	1.2	10.5	4.7	1.2	12	5.1	1.2	15.5	5.2	1.4	19.5	5.4	1.4	26.5
470L/K	5	1.2	10.5	5	1.2	12	5.5	1.2	15.5	5.6	1.4	19.5	5.6	1.4	26.5
560L/K	5	1.4	10.5	5	1.4	12	5.5	1.4	15.5	5.6	1.6	19.5	5.6	1.6	26.5
680L/K	5.5	1.7	10.5	5.5	1.7	12	6	1.7	15.5	6.1	1.9	19.5	6.1	1.9	26.5
820K	3.8	0.8	10.5	3.8	0.8	12	4.3	0.8	15.5	4.4	1	19.5	5	1.1	26.5
101K	3.9	0.8	10.5	3.9	0.8	12	4.4	0.8	15.5	4.5	1	19.5	5.1	1.2	26.5
121K	4.1	0.9	10.5	4.1	0.9	12	4.5	0.9	15.5	4.6	1.1	19.5	5.3	1.3	26.5
151K	4.5	1.2	10.5	4.5	1.2	12	4.9	1.2	15.5	5.1	1.4	19.5	5.6	1.6	26.5
181K	4.1	1	10.5	4.1	1	12	4.5	1	15.5	4.7	1.2	19.5	5.2	1.4	26.5
201K	4.2	1	10.5	4.2	1	12	4.6	1	15.5	4.8	1.2	19.5	5.3	1.47	26.5
221K	4.3	1.1	10.5	4.3	1.1	12	4.7	1.1	15.5	4.9	1.3	19.5	5.4	1.5	26.5
241K	4.4	1.1	10.5	4.4	1.3	12	4.8	1.3	15.5	5	1.5	19.5	5.5	1.7	26.5
271K	4.6	1.3	10.5	4.6	1.4	12	5	1.4	15.5	5.2	1.5	19.5	5.7	1.9	26.5
301K	4.8	1.3	10.5	4.8	1.5	12	5.2	1.6	15.5	5.4	1.7	19.5	5.9	2.1	26.5
331K	4.9	1.3	10.5	4.9	1.5	12	5.3	1.6	15.5	5.5	1.7	19.5	6	2.1	26.5
361K	5.1	1.8	10.5	5.1	1.9	12	5.5	1.9	15.5	5.7	2.1	19.5	6.2	2.3	26.5
391K	5.3	2	11	5.3	2	12.5	5.7	2.2	16	5.9	2.2	20	6.4	2.4	26.5
431K	6.1	2.1	11	6.1	2	12.5	6.5	2.5	16	6.7	2.5	20	7.2	2.7	26.5
471K	6.4	2.2	11	6.4	2.3	12.5	6.8	2.6	16	7	2.7	20	7.5	2.9	27
511K	6.6	2.5	11.5	6.6	2.5	13	7	3.1	16.5	7.2	3.1	20.5	7.7	3.3	27
561K	6.9	2.8	11.5	6.9	2.8	13	7.3	3.4	16.5	7.5	3.4	20.5	8	3.6	27
621K	7.2	3.1	11.5	7.2	3.1	13	7.6	4	16.5	7.8	3.8	20.5	8.3	4.1	27
681K	7.5	3.4	11.5	7.5	3.4	13	8	4.4	16.5	8.2	4.1	20.5	8.7	4.4	27
751K	7.9	3.7	11.5	7.9	3.7	13	8.4	4.4	16.5	8.6	4.3	20.5	9.1	4.5	27
781K	---	---	---	8.1	3.9	13	8.6	4.6	16.5	8.8	4.6	20.5	9.3	4.8	27
821K	---	---	---	8.3	4.1	13	8.8	4.6	16.5	9	4.6	20.5	9.5	4.8	27
911K	---	---	---	---	---	---	9.4	5.4	16.5	9.6	5.4	20.5	10.1	5.7	27
102K	---	---	---	---	---	---	9.9	5.4	16.5	10.1	5.6	20.5	10.7	5.8	27
112K	---	---	---	---	---	---	10.5	5.7	16.5	10.7	6.1	20.5	11.2	6.3	27
122K	---	---	---	---	---	---	10.9	6.3	17	10.9	6.7	21	11.3	6.9	27.5
142K	---	---	---	---	---	---	11.9	7.4	17.5	11.9	7.8	21.5	12.8	8	28
162K	---	---	---	---	---	---	13.1	8.6	18	13.1	9	22	13.7	9.2	28.5
182K	---	---	---	---	---	---	14.3	9.8	18.5	14.3	10.2	22.5	14.7	10.4	29

■ TAPING SPECIFICATIONS

1/2" pitch

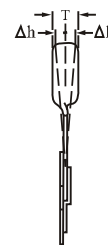
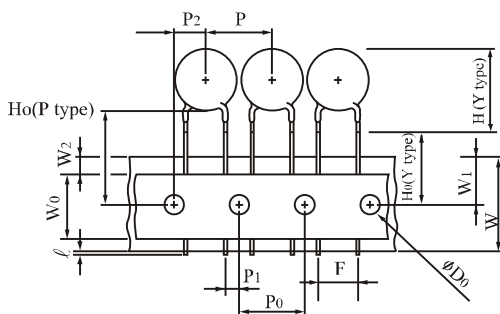

1.0" pitch

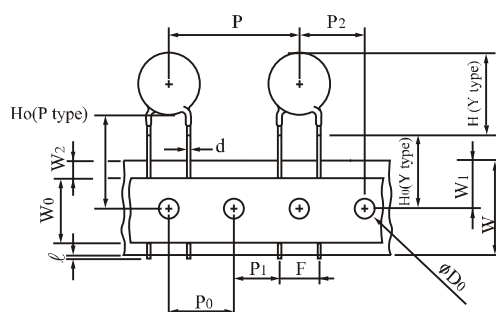

Symbols	Item	5 / 7 mm	10 / 14mm	20mm
	Cut out length	1.1 mm max.	1.1 mm max.	
H (Y Type)	Height of Top	See H Max. Table on page 4		
Ho (Y Type)	Height to seating plane	16.0 ± 0.5mm (*±1.0mm)	16.0 ± 0.5mm (*±1.0mm)	
Ho (P Type)	Height of component from hole center	16.0 ~ 21.0 mm	16.0 ~ 21.0 mm	
Δ h	Front to back deviation	0 ± 2.0 mm	0 ± 2.0 mm	
W	Carrier tape width	18.0 ^{+1.0} / _{-0.5} mm	18.0 ^{+1.0} / _{-0.5} mm	
W0	Hold down tape width	10.0mm	10.0mm	
W1	Sprocket hole position	9.0 ^{+0.75} / _{-0.5} mm	9.0 ^{+0.75} / _{-0.5} mm	
W2	Adhesive tape position	3.0 mm max.	3.0 mm max.	
F	Component head spacing	5.0 ^{+0.8} / _{-0.2} mm	7.5 ^{+0.8} / _{-0.2} mm	10 ^{+0.8} / _{-0.2} mm
P	Pitch of component	12.7 ± 1.0 mm	25.4 ± 1.0 mm	
P0	Sprocket hole pitch	12.7 ± 0.3 mm	12.7 ± 0.3 mm	
P1	Lead length from hole center to lead	3.85 ± 0.7 mm	8.95 ± 0.7 mm	7.7 ± 0.7 mm
P2	Length from hole center to disk center	6.35 ± 1.3 mm	12.7 ± 1.3 mm	
D0	Sprocket hole diameter	4.0 ± 0.2 mm	4.0 ± 0.2 mm	
d	Lead wire diameter	0.6 ± 0.05 mm	0.8 ± 0.05 mm	1.0 ± 0.05 mm
T	Disk thickness	See Table of T Max. on page 4		
t1	Total thickness tape	0.7 ± 0.05 mm	0.7 ± 0.05 mm	
t2	Total thickness	1.6 mm max.	1.8 mm max.	

* for manual line

■ **PACKAGING**

in mm

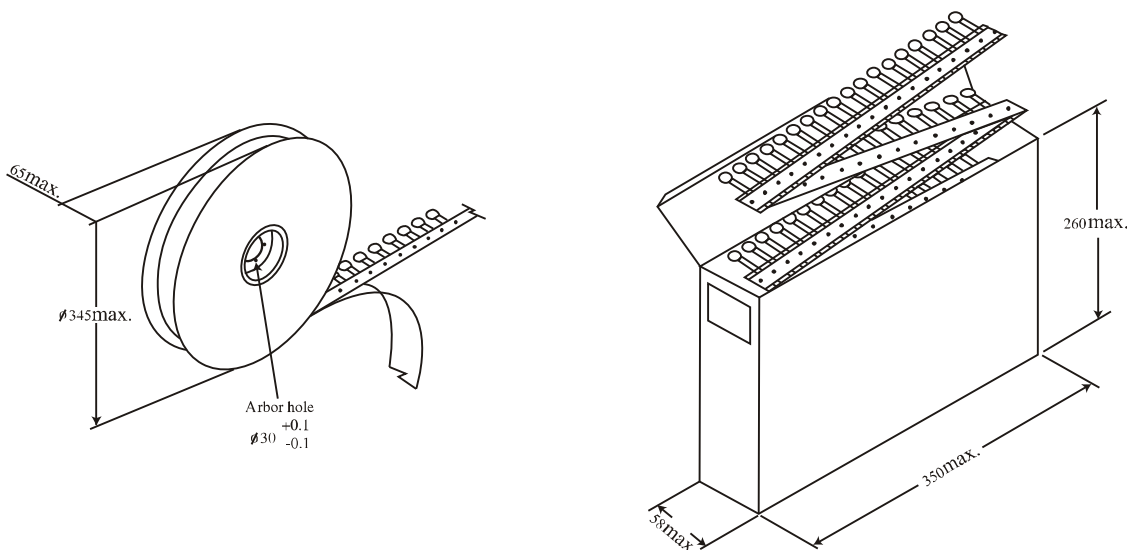

Quantity per Packing Unit

in Pcs

Series Part No.	5mm			7mm			10mm			14mm			20mm		
	Bulk (box)	Reel	Ammo	Bulk (box)	Reel	Ammo	Bulk (box)	Reel	Ammo	Bulk (box)	Reel	Ammo	Bulk (box)	Reel	Ammo
180M ~ 470K	5000	1500	1500	5000	1500	1500	2500	1000	500	1500	750	500	750	500	500
560K ~ 680K	5000	1500	1000	5000	1500	1000	2500	1000	500	1500	750	500	750	500	500
820K ~ 391K	5000	1500	1500	5000	1500	1500	2500	1000	500	1500	750	500	750	500	500
431K ~ 471K	5000	1500	1000	5000	1000	1000	2000	750	500	1500	750	500	750	500	500
511K ~ 821K	4000	1000	1000	4000	1000	1000	1500	500	500	750	500	500	450	500	500
911K ~ 122K	---	---	---	---	---	---	1500	500	350	750	500	350	450	---	---
142K ~ 182K	---	---	---	---	---	---	750	---	---	450	---	---	300	---	---

Packaging	Bulk (box)	Reel	Reel (14mm, 20mm)	Ammo (5mm, 7mm)	Ammo (10mm, 14mm)	Ammo (20mm)
Box size (mm)	290*155*110	350*350*105	346*346*72	335*245*43	347*246*50	348*255*60
Carton size (mm)	328*310*250	370*370*590	370*370*468	515*354*258	515*364*246	535*365*275
One carton with	4 boxes	5 boxes (10 reels)	6 boxes (6 reels)	10 boxes	8 boxes	8 boxes