

The Ultra high surge current type JVR-U series are specifically designed for Ultra high transient surge suppression. They are radial leaded varistors (MOVs or VDRs) designed to be the continuously used across AC line primary or DC circuit.

Operating Temperature -40°C~+85°C

■ **RECOGNITION** : made for RFE by UL shop Joyin



Agency	File Number	Monogram
UL/cUL	E325508	
VDE	Certificate No. 005937	
CQC	CQC07001019159 /9161/9162/9163/9164	

■ **CHARACTERISTICS & RATINGS**

Part Number	Varistor Voltage at 0.1mA		Maximum Allowable Voltage		Maximum Clamping Voltage		Withstanding Surge Current (8/20µs) 1 Time (A)	Nominal Discharge Current (8/20µs) In (KA)	Rated Wattage (W)	Energy (10/1000µs) (J)
	DC (V)	Tolerance	AC rms (V)	DC (V)	V@ ic (V)	ic (A)				
JVR10U181K87***	180	±10%	115	150	300	25	4500	3	0.4	47
JVR10U201K87***	200		130	170	340					52
JVR10U221K87***	220		140	180	360					58
JVR10U241K87***	240		150	200	395					64
JVR10U271K87***	270		175	225	455					67
JVR10U301K87***	300		195	250	505					70
JVR10U331K87***	330		210	275	550					72
JVR10U361K87***	360		230	300	595					76
JVR10U391K87***	390		250	320	650					82
JVR10U431K87***	430		275	350	710					93
JVR10U471K87***	470		300	385	775					99
JVR10U511K87***	510		320	418	842					107
JVR10U561K87***	560		350	460	920					113
JVR10U621K87***	620		385	505	1025					125
JVR10U681K87***	680		420	560	1120					128
JVR10U751K87***	750		460	615	1240					134
JVR10U781K87***	780		485	640	1290					139
JVR10U821K87***	820		510	670	1355					146
JVR10U911K87***	910		550	745	1500					152
JVR10U102K87***	1000		625	825	1650					170
JVR10U112K87***	1100	680	895	1815	180					

\*\*\* Replace with Lead & Packaging code

■ 10mm PULSE LIFETIME RATINGS

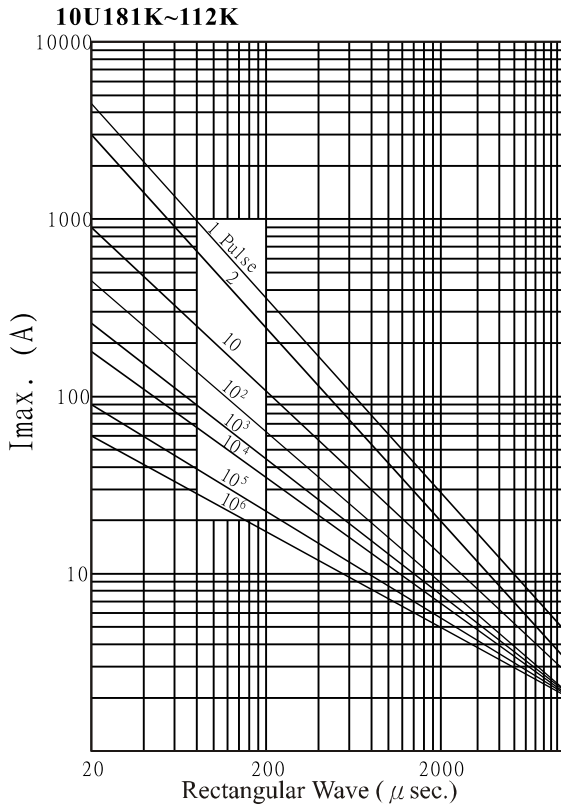

■ 10mm V-I CHARACTERISTIC CURVE

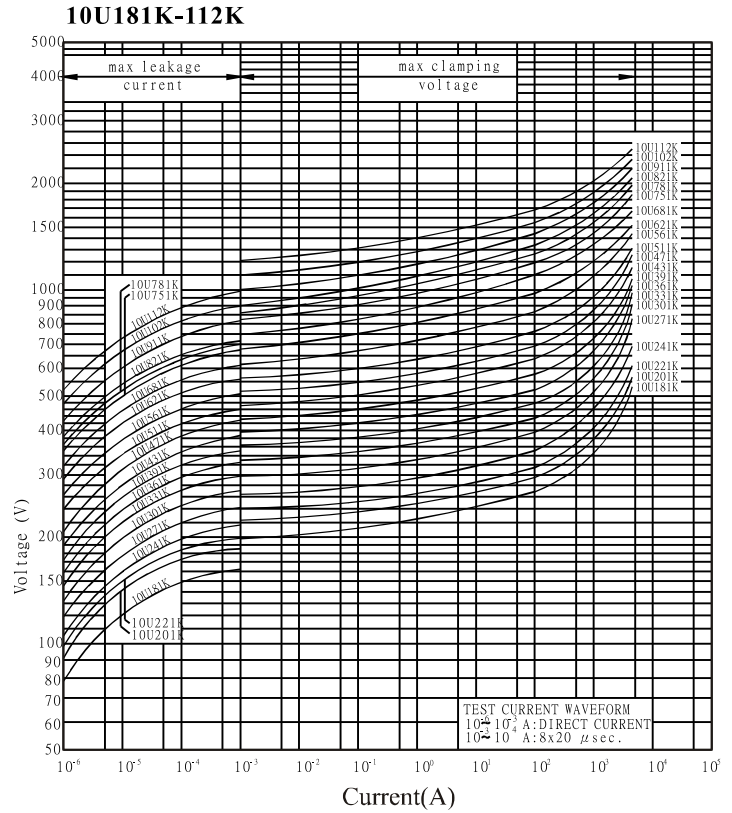

■ CURENT - VOLTAGE CHARACTERISTICS

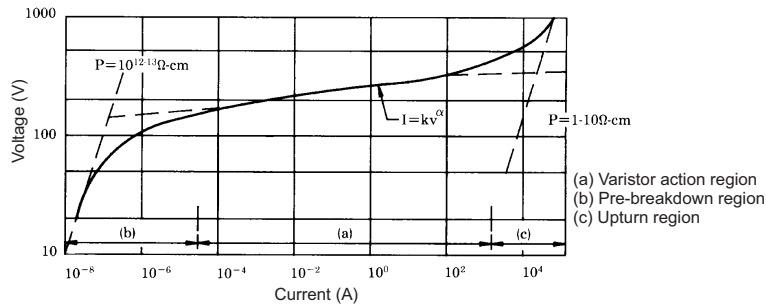

Operating & Storage Temperature Range :  $-40^\circ\text{C}$  to  $+85^\circ\text{C}$   
Temperature Coefficient of Voltage :  $0 \sim 0.05\% / ^\circ\text{C}$  max.

**■ PART NUMBER EXAMPLE**

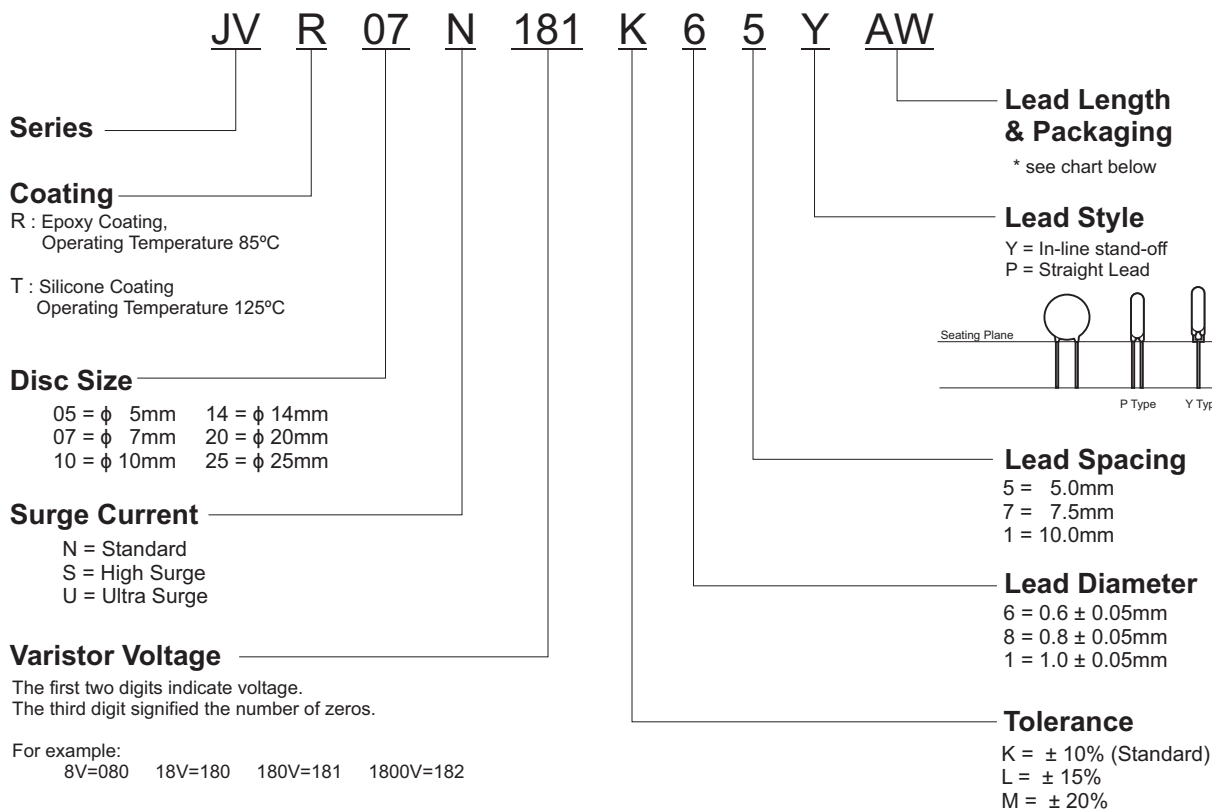

**■ LEAD LENGTH & PACKAGING**

Stand-off Formed (Y Type)

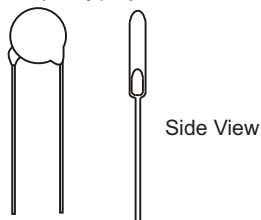

Straight Lead (P Type)

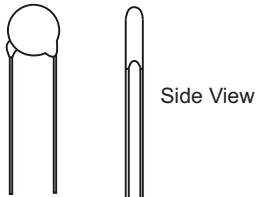

Lead Type	Code	Dimension	Package
Y Type Leads	50	L = $5 \pm 1$ mm	Bulk
	U4	L = 24mm min.	Bulk
	AW	H <sub>0</sub> = 16mm	Ammo
	RW	H <sub>0</sub> = 16mm	Reel
P Type Leads	50	L = $5 \pm 1$ mm	Bulk
	U5	L = 25mm min.	Bulk
	AY	H <sub>0</sub> = 20mm	Ammo
	RY	H <sub>0</sub> = 20mm	Reel

\* H<sub>0</sub> see the drawing on page 5

### LEAD STYLES & DIMENSIONS (mm)

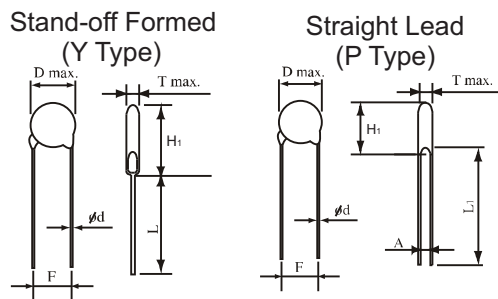

Diameter	5mm	7mm	10mm	14mm	20mm
D max	7.5	9.0	12.5	16.5	23.0
d $\pm$ 0.05	0.6	0.6	0.8	0.8	1.0
F $\pm$ 1.0	5.0	5.0	7.5	7.5	10.0
H max.	11.0	13.0	18/*19	22/*23	28/*29
L1 max.	25.0	25.0	25.0	25.0	25.0
L min.	24.0	24.0	24.0	24.0	24.0

\* Just for 182K

Table of T & H<sub>1</sub> max, A  $\pm$  0.8

Diameter	5mm			7mm			10mm			14mm			20mm		
	T	A	H <sub>1</sub>	T	A	H <sub>1</sub>	T	A	H <sub>1</sub>	T	A	H <sub>1</sub>	T	A	H <sub>1</sub>
180M	4.5	0.8	10.5	4.5	0.8	12	4.9	0.8	15.5	5	0.9	19.5	---	---	---
220M/L	4.5	0.9	10.5	4.5	0.9	12	4.9	0.9	15.5	5	1	19.5	5.3	1	26.5
270M/K	4.7	0.9	10.5	4.7	0.9	12	5.1	0.9	15.5	5.2	1.1	19.5	5.4	1.1	26.5
330M/K	4.7	1	10.5	4.7	1	12	5.1	1	15.5	5.2	1.2	19.5	5.4	1.2	26.5
390L/K	4.7	1.2	10.5	4.7	1.2	12	5.1	1.2	15.5	5.2	1.4	19.5	5.4	1.4	26.5
470L/K	5	1.2	10.5	5	1.2	12	5.5	1.2	15.5	5.6	1.4	19.5	5.6	1.4	26.5
560L/K	5	1.4	10.5	5	1.4	12	5.5	1.4	15.5	5.6	1.6	19.5	5.6	1.6	26.5
680L/K	5.5	1.7	10.5	5.5	1.7	12	6	1.7	15.5	6.1	1.9	19.5	6.1	1.9	26.5
820K	3.8	0.8	10.5	3.8	0.8	12	4.3	0.8	15.5	4.4	1	19.5	5	1.1	26.5
101K	3.9	0.8	10.5	3.9	0.8	12	4.4	0.8	15.5	4.5	1	19.5	5.1	1.2	26.5
121K	4.1	0.9	10.5	4.1	0.9	12	4.5	0.9	15.5	4.6	1.1	19.5	5.3	1.3	26.5
151K	4.5	1.2	10.5	4.5	1.2	12	4.9	1.2	15.5	5.1	1.4	19.5	5.6	1.6	26.5
181K	4.1	1	10.5	4.1	1	12	4.5	1	15.5	4.7	1.2	19.5	5.2	1.4	26.5
201K	4.2	1	10.5	4.2	1	12	4.6	1	15.5	4.8	1.2	19.5	5.3	1.47	26.5
221K	4.3	1.1	10.5	4.3	1.1	12	4.7	1.1	15.5	4.9	1.3	19.5	5.4	1.5	26.5
241K	4.4	1.1	10.5	4.4	1.3	12	4.8	1.3	15.5	5	1.5	19.5	5.5	1.7	26.5
271K	4.6	1.3	10.5	4.6	1.4	12	5	1.4	15.5	5.2	1.5	19.5	5.7	1.9	26.5
301K	4.8	1.3	10.5	4.8	1.5	12	5.2	1.6	15.5	5.4	1.7	19.5	5.9	2.1	26.5
331K	4.9	1.3	10.5	4.9	1.5	12	5.3	1.6	15.5	5.5	1.7	19.5	6	2.1	26.5
361K	5.1	1.8	10.5	5.1	1.9	12	5.5	1.9	15.5	5.7	2.1	19.5	6.2	2.3	26.5
391K	5.3	2	11	5.3	2	12.5	5.7	2.2	16	5.9	2.2	20	6.4	2.4	26.5
431K	6.1	2.1	11	6.1	2	12.5	6.5	2.5	16	6.7	2.5	20	7.2	2.7	26.5
471K	6.4	2.2	11	6.4	2.3	12.5	6.8	2.6	16	7	2.7	20	7.5	2.9	27
511K	6.6	2.5	11.5	6.6	2.5	13	7	3.1	16.5	7.2	3.1	20.5	7.7	3.3	27
561K	6.9	2.8	11.5	6.9	2.8	13	7.3	3.4	16.5	7.5	3.4	20.5	8	3.6	27
621K	7.2	3.1	11.5	7.2	3.1	13	7.6	4	16.5	7.8	3.8	20.5	8.3	4.1	27
681K	7.5	3.4	11.5	7.5	3.4	13	8	4.4	16.5	8.2	4.1	20.5	8.7	4.4	27
751K	7.9	3.7	11.5	7.9	3.7	13	8.4	4.4	16.5	8.6	4.3	20.5	9.1	4.5	27
781K	---	---	---	8.1	3.9	13	8.6	4.6	16.5	8.8	4.6	20.5	9.3	4.8	27
821K	---	---	---	8.3	4.1	13	8.8	4.6	16.5	9	4.6	20.5	9.5	4.8	27
911K	---	---	---	---	---	---	9.4	5.4	16.5	9.6	5.4	20.5	10.1	5.7	27
102K	---	---	---	---	---	---	9.9	5.4	16.5	10.1	5.6	20.5	10.7	5.8	27
112K	---	---	---	---	---	---	10.5	5.7	16.5	10.7	6.1	20.5	11.2	6.3	27
122K	---	---	---	---	---	---	10.9	6.3	17	10.9	6.7	21	11.3	6.9	27.5
142K	---	---	---	---	---	---	11.9	7.4	17.5	11.9	7.8	21.5	12.8	8	28
162K	---	---	---	---	---	---	13.1	8.6	18	13.1	9	22	13.7	9.2	28.5
182K	---	---	---	---	---	---	14.3	9.8	18.5	14.3	10.2	22.5	14.7	10.4	29

■ TAPING SPECIFICATIONS

1/2" pitch

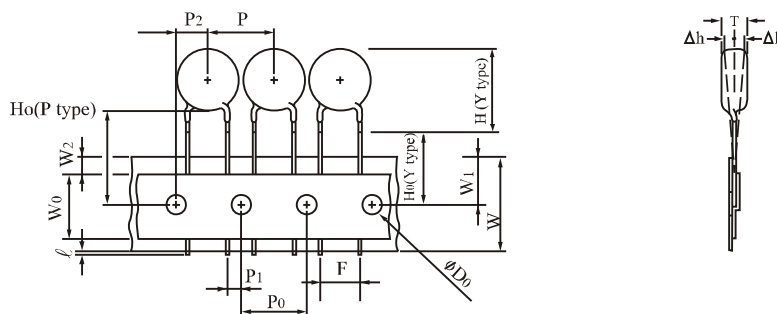

1.0" pitch

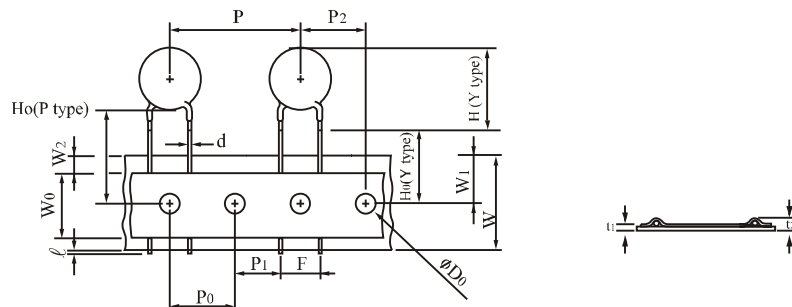

Symbols	Item	5 / 7 mm	10 / 14mm	20mm
	Cut out length	1.1 mm max.	1.1 mm max.	
H (Y Type)	Height of Top	See H Max. Table on page 4		
Ho (Y Type)	Height to seating plane	16.0 ± 0.5mm (*±1.0mm)	16.0 ± 0.5mm (*±1.0mm)	
Ho (P Type)	Height of component from hole center	16.0 ~ 21.0 mm	16.0 ~ 21.0 mm	
Δ h	Front to back deviation	0 ± 2.0 mm	0 ± 2.0 mm	
W	Carrier tape width	18.0 <sup>+1.0</sup> / <sub>-0.5</sub> mm	18.0 <sup>+1.0</sup> / <sub>-0.5</sub> mm	
W0	Hold down tape width	10.0mm	10.0mm	
W1	Sprocket hole position	9.0 <sup>+0.75</sup> / <sub>-0.5</sub> mm	9.0 <sup>+0.75</sup> / <sub>-0.5</sub> mm	
W2	Adhesive tape position	3.0 mm max.	3.0 mm max.	
F	Component head spacing	5.0 <sup>+0.8</sup> / <sub>-0.2</sub> mm	7.5 <sup>+0.8</sup> / <sub>-0.2</sub> mm	10 <sup>+0.8</sup> / <sub>-0.2</sub> mm
P	Pitch of component	12.7 ± 1.0 mm	25.4 ± 1.0 mm	
P0	Sprocket hole pitch	12.7 ± 0.3 mm	12.7 ± 0.3 mm	
P1	Lead length from hole center to lead	3.85 ± 0.7 mm	8.95 ± 0.7 mm	7.7 ± 0.7 mm
P2	Length from hole center to disk center	6.35 ± 1.3 mm	12.7 ± 1.3 mm	
D0	Sprocket hole diameter	4.0 ± 0.2 mm	4.0 ± 0.2 mm	
d	Lead wire diameter	0.6 ± 0.05 mm	0.8 ± 0.05 mm	1.0 ± 0.05 mm
T	Disk thickness	See Table of T Max. on page 4		
t1	Total thickness tape	0.7 ± 0.05 mm	0.7 ± 0.05 mm	
t2	Total thickness	1.6 mm max.	1.8 mm max.	

\* for manual line

■ **PACKAGING**

in mm

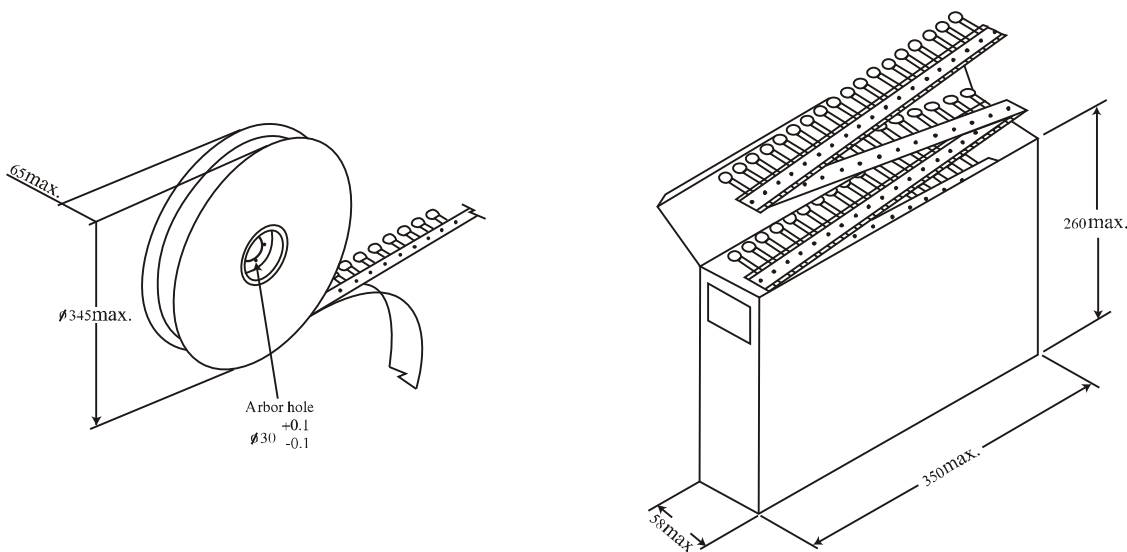

**Quantity per Packing Unit**

in Pcs

Series Part No.	5mm			7mm			10mm			14mm			20mm		
	Bulk (box)	Reel	Ammo	Bulk (box)	Reel	Ammo	Bulk (box)	Reel	Ammo	Bulk (box)	Reel	Ammo	Bulk (box)	Reel	Ammo
180M ~ 470K	5000	1500	1500	5000	1500	1500	2500	1000	500	1500	750	500	750	500	500
560K ~ 680K	5000	1500	1000	5000	1500	1000	2500	1000	500	1500	750	500	750	500	500
820K ~ 391K	5000	1500	1500	5000	1500	1500	2500	1000	500	1500	750	500	750	500	500
431K ~ 471K	5000	1500	1000	5000	1000	1000	2000	750	500	1500	750	500	750	500	500
511K ~ 821K	4000	1000	1000	4000	1000	1000	1500	500	500	750	500	500	450	500	500
911K ~ 122K	---	---	---	---	---	---	1500	500	350	750	500	350	450	---	---
142K ~ 182K	---	---	---	---	---	---	750	---	---	450	---	---	300	---	---

Packaging	Bulk (box)	Reel	Reel (14mm, 20mm)	Ammo (5mm, 7mm)	Ammo (10mm, 14mm)	Ammo (20mm)
Box size (mm)	290*155*110	350*350*105	346*346*72	335*245*43	347*246*50	348*255*60
Carton size (mm)	328*310*250	370*370*590	370*370*468	515*354*258	515*364*246	535*365*275
One carton with	4 boxes	5 boxes (10 reels)	6 boxes (6 reels)	10 boxes	8 boxes	8 boxes