

The normal type N series of Metal Oxide Varistor (MOV) are radial lead varistors (also known as Voltage Dependent Resistors or VDRs) that are designed to be used continuously across AC line primary or DC circuit for transient voltage and surge suppression.

Operating Temperature -40°C~+85°C

■ **RECOGNITION** : made for RFE by UL shop Joyin



Agency	File Number	Monogram
UL/cUL	E325508	
VDE	Certificate No. 5937	
CQC	CQC07001019159 /9161/9162/9163/9164	

■ **CHARACTERISTICS & RATINGS**

Part Number	Varistor Voltage at 0.1mA		Maximum Allowable Voltage		Maximum Clamping Voltage		Withstanding Surge Current (8/20µs)	Nominal Discharge Current (8/20µs)	Rated Wattage	Energy (10/1000µs)
	DC (V)	Tolerance	AC rms (V)	DC (V)	V @ ic (V)	ic (A)	1 Time (A)	In (KA)	(W)	(J)
JVR25N201K11◆◆◆	200	10%	130	170	355	150	18000	5	1.2	190
JVR25N221K11◆◆◆	220		140	180	380					205
JVR25N241K11◆◆◆	240		150	200	415					225
JVR25N271K11◆◆◆	270		175	225	445					255
JVR25N301K11◆◆◆	300		195	250	495					280
JVR25N331K11◆◆◆	330		210	275	545					305
JVR25N361K11◆◆◆	360		230	300	595					330
JVR25N391K11◆◆◆	390		250	320	645					360
JVR25N431K11◆◆◆	430		275	350	710					380
JVR25N471K11◆◆◆	470		300	385	775					400
JVR25N511K11◆◆◆	510		320	418	840					420
JVR25N561K11◆◆◆	560		350	460	925					440
JVR25N621K11◆◆◆	620		385	505	1025					460
JVR25N681K11◆◆◆	680		420	560	1125					480
JVR25N751K11◆◆◆	750		460	615	1240					520
JVR25N781K11◆◆◆	780		485	640	1290					540
JVR25N821K11◆◆◆	820		510	670	1360					570
JVR25N911K11◆◆◆	910		550	745	1500					620

◆◆◆ Replace with Lead & Packaging code

■ 20mm PULSE LIFETIME RATINGS

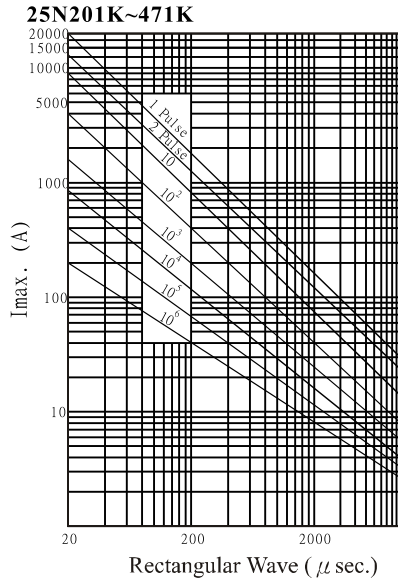

■ 20mm V-I CHARACTERISTIC CURVE

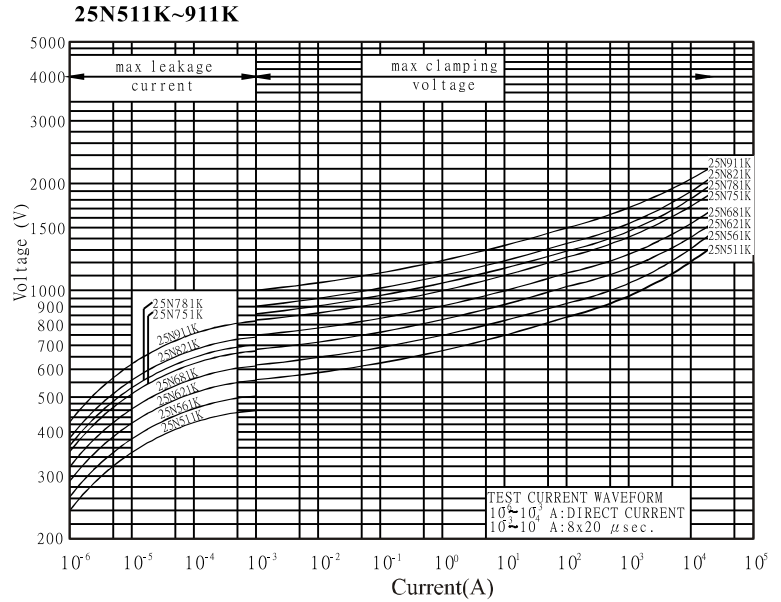
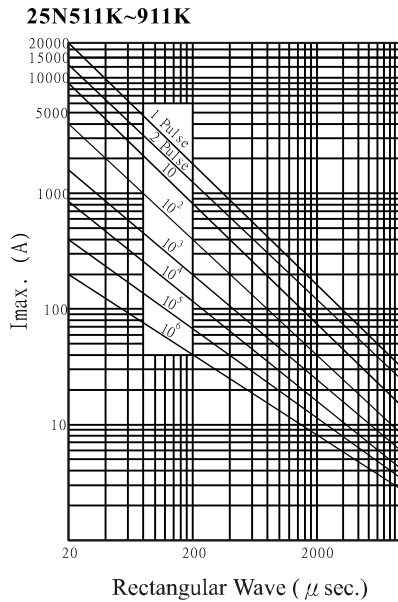
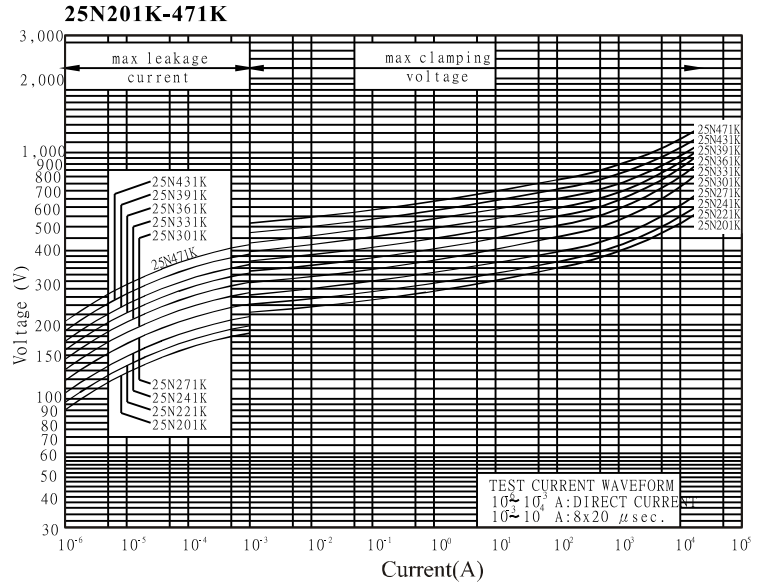

■ CURENT - VOLTAGE CHARACTERISTICS

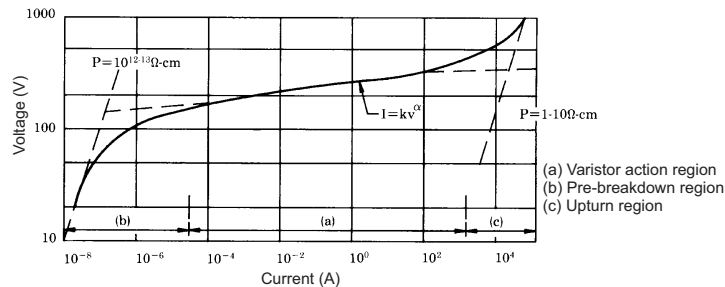

Operating & Storage Temperature Range : -40°C to +85°C
Temperature Coefficient of Voltage : 0~0.05% / °C max.

■ PART NUMBER EXAMPLE

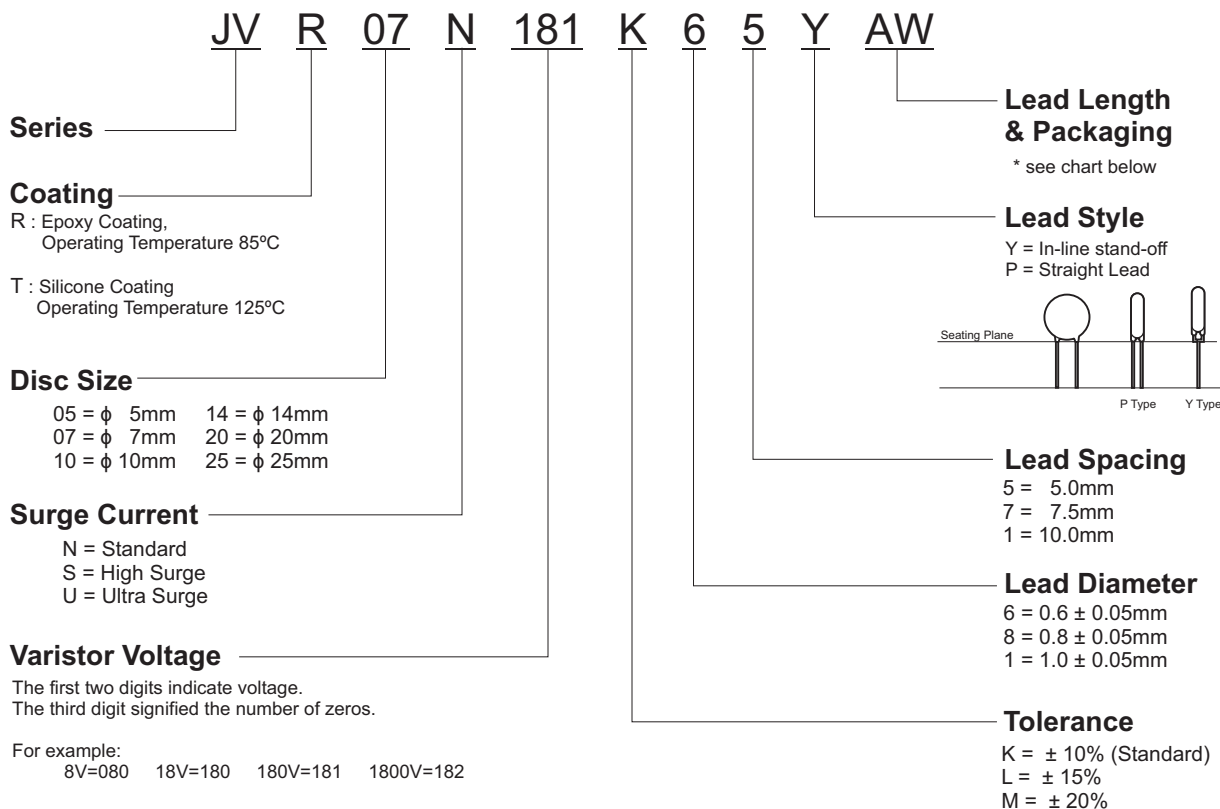

■ LEAD LENGTH & PACKAGING

Stand-off Formed
(Y Type)

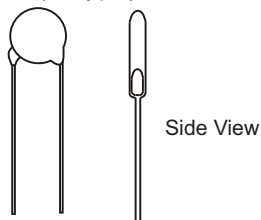

Straight Lead
(P Type)

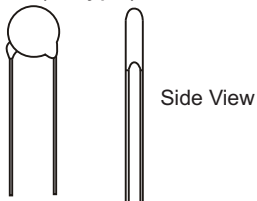

Lead Type	Code	Dimension	Package
Y Type Leads	50	L = 5 ± 1 mm	Bulk
	U4	L = 24mm min.	Bulk
	AW	H ₀ = 16mm	Ammo
	RW	H ₀ = 16mm	Reel
P Type Leads	50	L = 5 ± 1 mm	Bulk
	U5	L = 25mm min.	Bulk
	AY	H ₀ = 20mm	Ammo
	RY	H ₀ = 20mm	Reel

* H₀ see the drawing on page 5

LEAD STYLES & DIMENSIONS (mm)

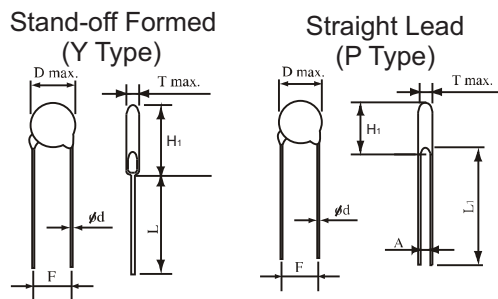

Diameter	5mm	7mm	10mm	14mm	20mm
D max	7.5	9.0	12.5	16.5	23.0
d ± 0.05	0.6	0.6	0.8	0.8	1.0
F ± 1.0	5.0	5.0	7.5	7.5	10.0
H max.	11.0	13.0	18/*19	22/*23	28/*29
L1 max.	25.0	25.0	25.0	25.0	25.0
L min.	24.0	24.0	24.0	24.0	24.0

* Just for 182K

Table of T & H₁ max, A ± 0.8

Diameter	5mm			7mm			10mm			14mm			20mm		
	T	A	H ₁	T	A	H ₁	T	A	H ₁	T	A	H ₁	T	A	H ₁
180M	4.5	0.8	10.5	4.5	0.8	12	4.9	0.8	15.5	5	0.9	19.5	---	---	---
220M/L	4.5	0.9	10.5	4.5	0.9	12	4.9	0.9	15.5	5	1	19.5	5.3	1	26.5
270M/K	4.7	0.9	10.5	4.7	0.9	12	5.1	0.9	15.5	5.2	1.1	19.5	5.4	1.1	26.5
330M/K	4.7	1	10.5	4.7	1	12	5.1	1	15.5	5.2	1.2	19.5	5.4	1.2	26.5
390L/K	4.7	1.2	10.5	4.7	1.2	12	5.1	1.2	15.5	5.2	1.4	19.5	5.4	1.4	26.5
470L/K	5	1.2	10.5	5	1.2	12	5.5	1.2	15.5	5.6	1.4	19.5	5.6	1.4	26.5
560L/K	5	1.4	10.5	5	1.4	12	5.5	1.4	15.5	5.6	1.6	19.5	5.6	1.6	26.5
680L/K	5.5	1.7	10.5	5.5	1.7	12	6	1.7	15.5	6.1	1.9	19.5	6.1	1.9	26.5
820K	3.8	0.8	10.5	3.8	0.8	12	4.3	0.8	15.5	4.4	1	19.5	5	1.1	26.5
101K	3.9	0.8	10.5	3.9	0.8	12	4.4	0.8	15.5	4.5	1	19.5	5.1	1.2	26.5
121K	4.1	0.9	10.5	4.1	0.9	12	4.5	0.9	15.5	4.6	1.1	19.5	5.3	1.3	26.5
151K	4.5	1.2	10.5	4.5	1.2	12	4.9	1.2	15.5	5.1	1.4	19.5	5.6	1.6	26.5
181K	4.1	1	10.5	4.1	1	12	4.5	1	15.5	4.7	1.2	19.5	5.2	1.4	26.5
201K	4.2	1	10.5	4.2	1	12	4.6	1	15.5	4.8	1.2	19.5	5.3	1.47	26.5
221K	4.3	1.1	10.5	4.3	1.1	12	4.7	1.1	15.5	4.9	1.3	19.5	5.4	1.5	26.5
241K	4.4	1.1	10.5	4.4	1.3	12	4.8	1.3	15.5	5	1.5	19.5	5.5	1.7	26.5
271K	4.6	1.3	10.5	4.6	1.4	12	5	1.4	15.5	5.2	1.5	19.5	5.7	1.9	26.5
301K	4.8	1.3	10.5	4.8	1.5	12	5.2	1.6	15.5	5.4	1.7	19.5	5.9	2.1	26.5
331K	4.9	1.3	10.5	4.9	1.5	12	5.3	1.6	15.5	5.5	1.7	19.5	6	2.1	26.5
361K	5.1	1.8	10.5	5.1	1.9	12	5.5	1.9	15.5	5.7	2.1	19.5	6.2	2.3	26.5
391K	5.3	2	11	5.3	2	12.5	5.7	2.2	16	5.9	2.2	20	6.4	2.4	26.5
431K	6.1	2.1	11	6.1	2	12.5	6.5	2.5	16	6.7	2.5	20	7.2	2.7	26.5
471K	6.4	2.2	11	6.4	2.3	12.5	6.8	2.6	16	7	2.7	20	7.5	2.9	27
511K	6.6	2.5	11.5	6.6	2.5	13	7	3.1	16.5	7.2	3.1	20.5	7.7	3.3	27
561K	6.9	2.8	11.5	6.9	2.8	13	7.3	3.4	16.5	7.5	3.4	20.5	8	3.6	27
621K	7.2	3.1	11.5	7.2	3.1	13	7.6	4	16.5	7.8	3.8	20.5	8.3	4.1	27
681K	7.5	3.4	11.5	7.5	3.4	13	8	4.4	16.5	8.2	4.1	20.5	8.7	4.4	27
751K	7.9	3.7	11.5	7.9	3.7	13	8.4	4.4	16.5	8.6	4.3	20.5	9.1	4.5	27
781K	---	---	---	8.1	3.9	13	8.6	4.6	16.5	8.8	4.6	20.5	9.3	4.8	27
821K	---	---	---	8.3	4.1	13	8.8	4.6	16.5	9	4.6	20.5	9.5	4.8	27
911K	---	---	---	---	---	---	9.4	5.4	16.5	9.6	5.4	20.5	10.1	5.7	27
102K	---	---	---	---	---	---	9.9	5.4	16.5	10.1	5.6	20.5	10.7	5.8	27
112K	---	---	---	---	---	---	10.5	5.7	16.5	10.7	6.1	20.5	11.2	6.3	27
122K	---	---	---	---	---	---	10.9	6.3	17	10.9	6.7	21	11.3	6.9	27.5
142K	---	---	---	---	---	---	11.9	7.4	17.5	11.9	7.8	21.5	12.8	8	28
162K	---	---	---	---	---	---	13.1	8.6	18	13.1	9	22	13.7	9.2	28.5
182K	---	---	---	---	---	---	14.3	9.8	18.5	14.3	10.2	22.5	14.7	10.4	29

■ TAPING SPECIFICATIONS

1/2" pitch

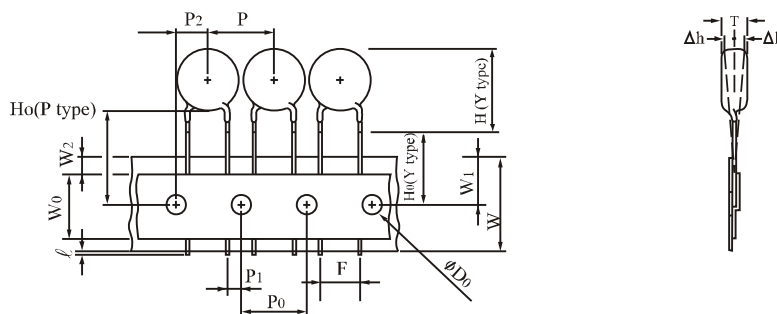

1.0" pitch

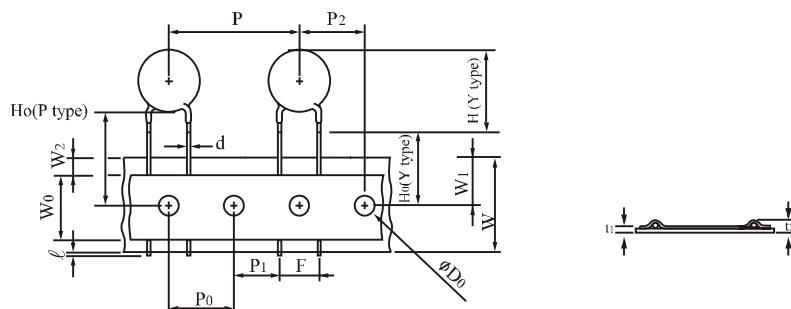

Symbols	Item	5 / 7 mm	10 / 14mm	20mm
	Cut out length	1.1 mm max.	1.1 mm max.	
H (Y Type)	Height of Top	See H Max. Table on page 4		
Ho (Y Type)	Height to seating plane	16.0 ± 0.5mm (*±1.0mm)	16.0 ± 0.5mm (*±1.0mm)	
Ho (P Type)	Height of component from hole center	16.0 ~ 21.0 mm	16.0 ~ 21.0 mm	
Δ h	Front to back deviation	0 ± 2.0 mm	0 ± 2.0 mm	
W	Carrier tape width	18.0 ^{+1.0} _{-0.5} mm	18.0 ^{+1.0} _{-0.5} mm	
W0	Hold down tape width	10.0mm	10.0mm	
W1	Sprocket hole position	9.0 ^{+0.75} _{-0.5} mm	9.0 ^{+0.75} _{-0.5} mm	
W2	Adhesive tape position	3.0 mm max.	3.0 mm max.	
F	Component head spacing	5.0 ^{+0.8} _{-0.2} mm	7.5 ^{+0.8} _{-0.2} mm	10 ^{+0.8} _{-0.2} mm
P	Pitch of component	12.7 ± 1.0 mm	25.4 ± 1.0 mm	
P0	Sprocket hole pitch	12.7 ± 0.3 mm	12.7 ± 0.3 mm	
P1	Lead length from hole center to lead	3.85 ± 0.7 mm	8.95 ± 0.7 mm	7.7 ± 0.7 mm
P2	Length from hole center to disk center	6.35 ± 1.3 mm	12.7 ± 1.3 mm	
D0	Sprocket hole diameter	4.0 ± 0.2 mm	4.0 ± 0.2 mm	
d	Lead wire diameter	0.6 ± 0.05 mm	0.8 ± 0.05 mm	1.0 ± 0.05 mm
T	Disk thickness	See Table of T Max. on page 4		
t1	Total thickness tape	0.7 ± 0.05 mm	0.7 ± 0.05 mm	
t2	Total thickness	1.6 mm max.	1.8 mm max.	

* for manual line

■ **PACKAGING**

in mm

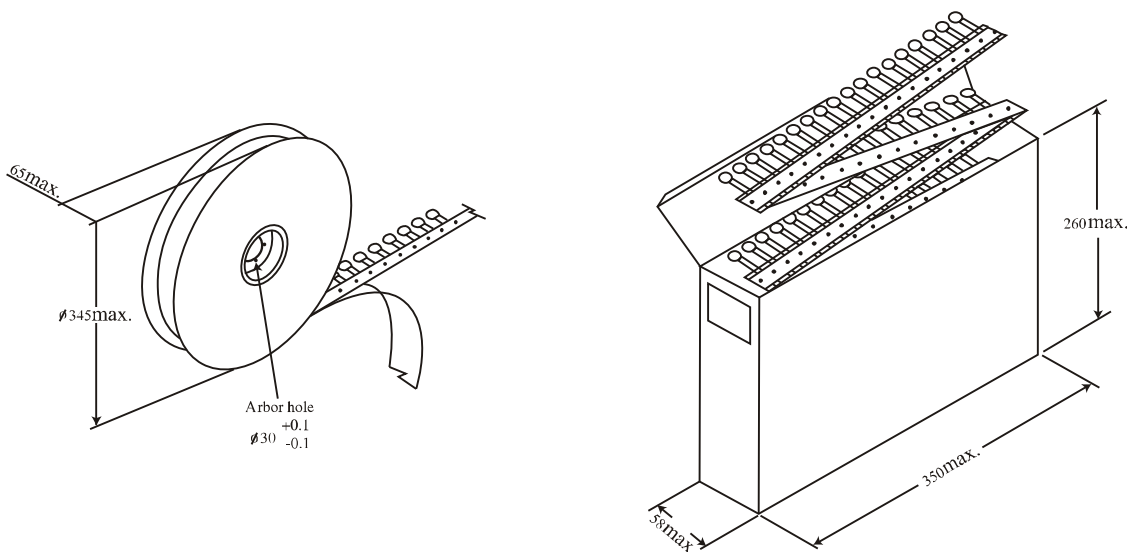

Quantity per Packing Unit

in Pcs

Series Part No.	5mm			7mm			10mm			14mm			20mm		
	Bulk (box)	Reel	Ammo	Bulk (box)	Reel	Ammo	Bulk (box)	Reel	Ammo	Bulk (box)	Reel	Ammo	Bulk (box)	Reel	Ammo
180M ~ 470K	5000	1500	1500	5000	1500	1500	2500	1000	500	1500	750	500	750	500	500
560K ~ 680K	5000	1500	1000	5000	1500	1000	2500	1000	500	1500	750	500	750	500	500
820K ~ 391K	5000	1500	1500	5000	1500	1500	2500	1000	500	1500	750	500	750	500	500
431K ~ 471K	5000	1500	1000	5000	1000	1000	2000	750	500	1500	750	500	750	500	500
511K ~ 821K	4000	1000	1000	4000	1000	1000	1500	500	500	750	500	500	450	500	500
911K ~ 122K	---	---	---	---	---	---	1500	500	350	750	500	350	450	---	---
142K ~ 182K	---	---	---	---	---	---	750	---	---	450	---	---	300	---	---

Packaging	Bulk (box)	Reel	Reel (14mm, 20mm)	Ammo (5mm, 7mm)	Ammo (10mm, 14mm)	Ammo (20mm)
Box size (mm)	290*155*110	350*350*105	346*346*72	335*245*43	347*246*50	348*255*60
Carton size (mm)	328*310*250	370*370*590	370*370*468	515*354*258	515*364*246	535*365*275
One carton with	4 boxes	5 boxes (10 reels)	6 boxes (6 reels)	10 boxes	8 boxes	8 boxes