

The normal type N series of Metal Oxide Varistor (MOV) are radial lead varistors (also known as Voltage Dependent Resistors or VDRs) that are designed to be used continuously across AC line primary or DC circuit for transient voltage and surge suppression.

Operating Temperature -40°C~+85°C

■ **RECOGNITION** : made for RFE by UL shop Joyin



Agency	File Number	Monogram
UL/cUL	E325508	
VDE	Certificate No. 5937	
CQC	CQC07001019159 /9161/9162/9163/9164	

■ **CHARACTERISTICS & RATINGS**

Part Number	Varistor Voltage at 0.1mA		Maximum Allowable Voltage		Maximum Clamping Voltage		Withstanding Surge Current (8/20µs)	Nominal Discharge Current (8/20µs)	Rated Wattage	Energy (10/1000µs)
	DC (V)	Tolerance	AC rms (V)	DC (V)	V @ ic (V)	ic (A)				
JVR10N180M87♦♦♦	18	20%	11	14	36	5	500	0.3	0.05	2.4
JVR10N220L87♦♦♦	22	15%	14	18	43					2.7
JVR10N270K87♦♦♦	27		17	22	53					3.5
JVR10N330K87♦♦♦	33		20	26	65					4.4
JVR10N390K87♦♦♦	39		25	31	77					4.7
JVR10N470K87♦♦♦	47		30	38	93					6
JVR10N560K87♦♦♦	56		35	45	110					7
JVR10N680K87♦♦♦	68		40	56	135					8.5
JVR10N820K87♦♦♦	82		50	65	135					11
JVR10N101K87♦♦♦	100		60	85	165					14
JVR10N121K87♦♦♦	120		75	100	200	16				
JVR10N151K87♦♦♦	150		95	125	250	22				
JVR10N181K87♦♦♦	180		115	150	300	26				
JVR10N201K87♦♦♦	200		130	170	340	28.5				
JVR10N221K87♦♦♦	220		140	180	360	31				
JVR10N241K87♦♦♦	240		150	200	395	33.5				
JVR10N271K87♦♦♦	270		175	225	455	39.5				
JVR10N301K87♦♦♦	300		195	250	505	42				
JVR10N331K87♦♦♦	330	10%	210	275	550	25	2500	1.5	0.4	46
JVR10N361K87♦♦♦	360		230	300	595					52
JVR10N391K87♦♦♦	390		250	320	650					60
JVR10N431K87♦♦♦	430		275	350	710					66
JVR10N471K87♦♦♦	470		300	385	775					70
JVR10N511K87♦♦♦	510		320	418	842					74
JVR10N561K87♦♦♦	560		350	460	920					78
JVR10N621K87♦♦♦	620		385	505	1025					82
JVR10N681K87♦♦♦	680		420	560	1120					86
JVR10N751K87♦♦♦	750		460	615	1240					90
JVR10N781K87♦♦♦	780	485	640	1290	92					
JVR10N821K87♦♦♦	820	510	670	1355	94					
JVR10N911K87♦♦♦	910	550	745	1500	102					
JVR10N102K87♦♦♦	1000	625	825	1650	112					
JVR10N112K87♦♦♦	1100	680	895	1815	124					
JVR10N122K87♦♦♦	1200	720	975	1980	134					
JVR10N142K87♦♦♦	1400	825	1135	2310	148					
JVR10N162K87♦♦♦	1600	920	1300	2640	162					
JVR10N182K87♦♦♦	1800	1000	1465	2970	174					

♦♦♦ Replace with Lead & Packaging code

■ **10mm PULSE LIFETIME RATINGS**

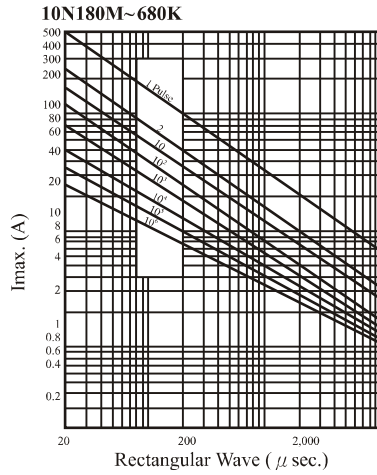

■ **10mm V-I CHARACTERISTIC CURVE**

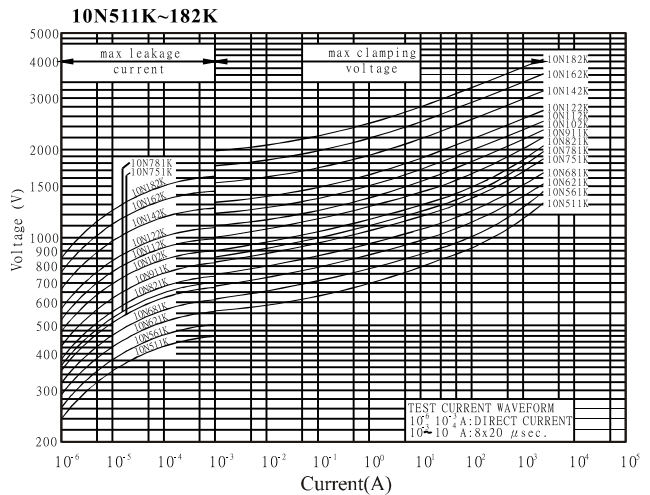
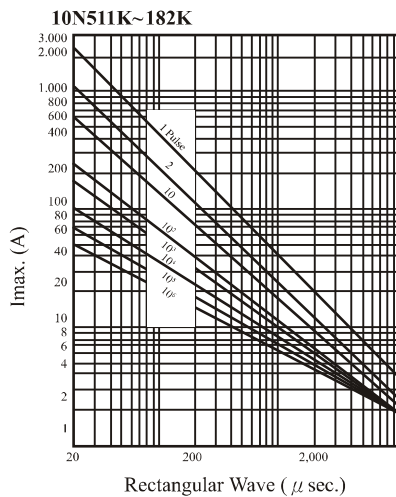
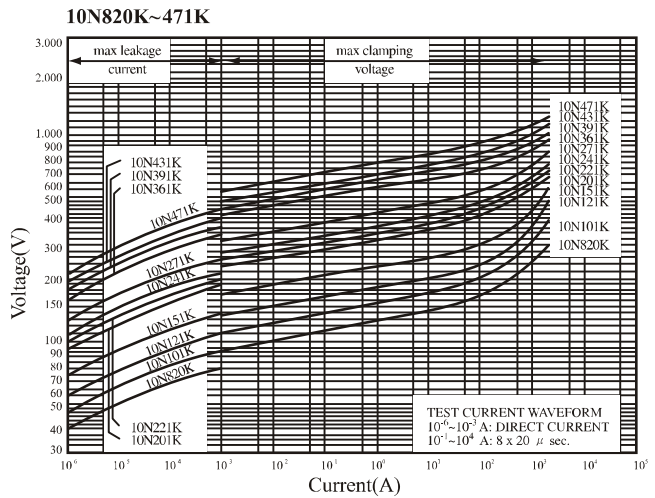
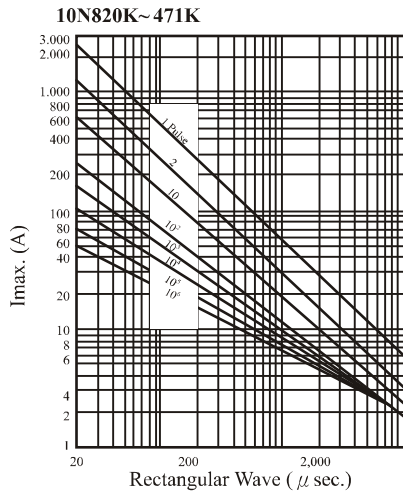
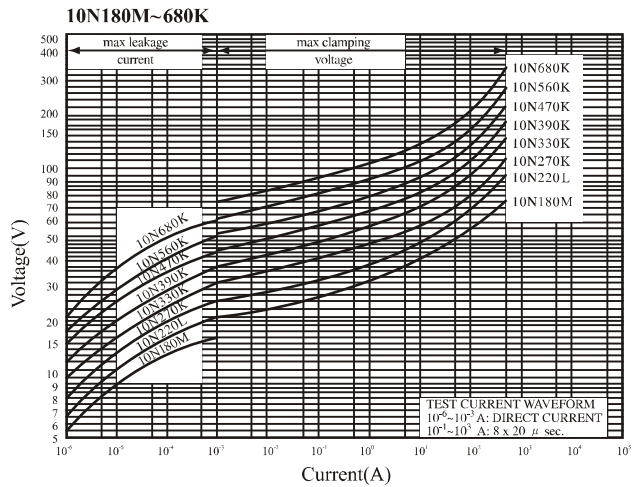

■ **CURRENT - VOLTAGE CHARACTERISTICS** : Please see 5mm or 7mm datasheet.

■ **PART NUMBER EXAMPLE**

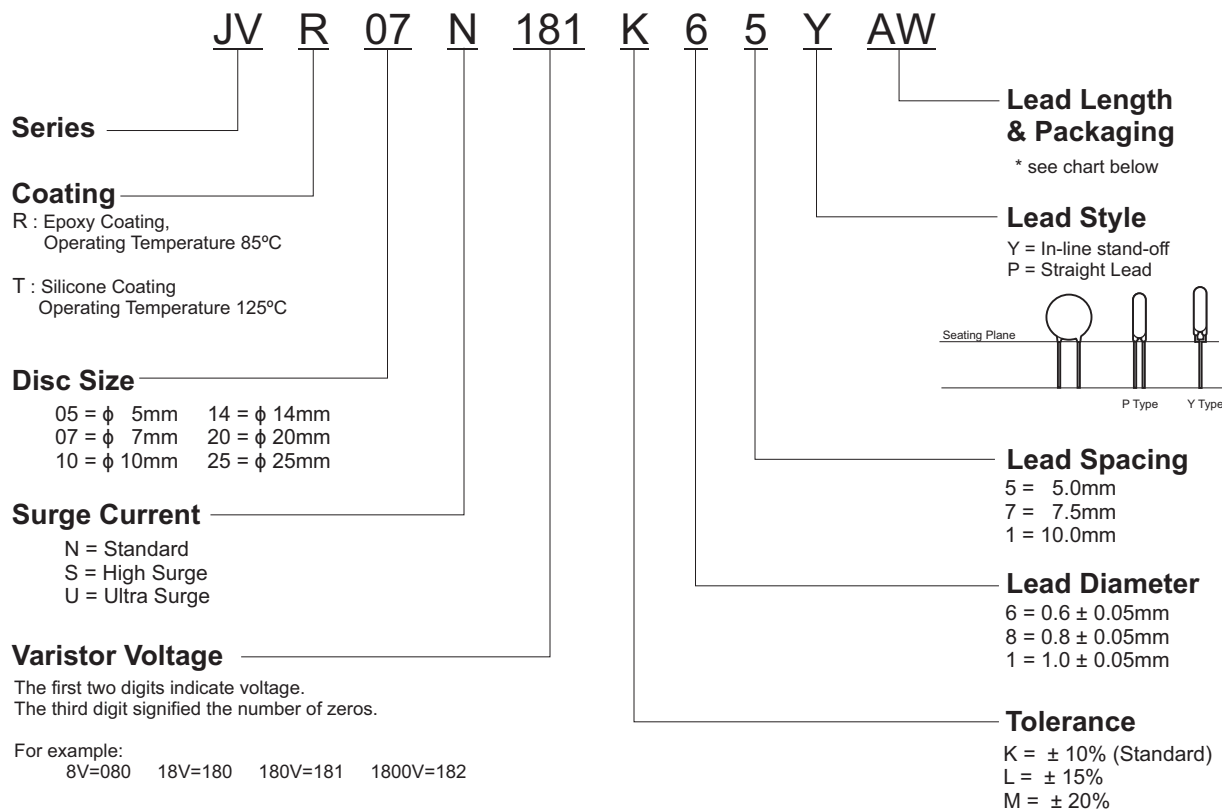

■ **LEAD LENGTH & PACKAGING**

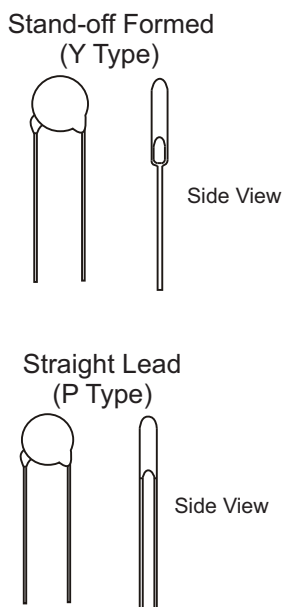

Lead Type	Code	Dimension	Package
Y Type Leads	50	L = 5 ± 1mm	Bulk
	U4	L = 24mm min.	Bulk
	AW	H <sub>0</sub> = 16mm	Ammo
	RW	H <sub>0</sub> = 16mm	Reel
P Type Leads	50	L = 5 ± 1mm	Bulk
	U5	L = 25mm min.	Bulk
	AY	H <sub>0</sub> = 20mm	Ammo
	RY	H <sub>0</sub> = 20mm	Reel

\* H<sub>0</sub> see the drawing on page 5

■ **LEAD STYLES & DIMENSIONS (mm)**

Stand-off Formed  
(Y Type)

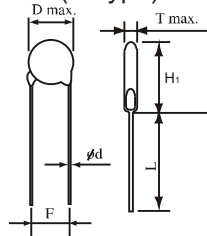

Straight Lead  
(P Type)

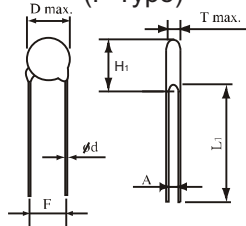

Diameter	5mm	7mm	10mm	14mm	20mm
D max	7.5	9.0	12.5	16.5	23.0
d ± 0.05	0.6	0.6	0.8	0.8	1.0
F ± 1.0	5.0	5.0	7.5	7.5	10.0
H max.	11.0	13.0	18/*19	22/*23	28/*29
L1 max.	25.0	25.0	25.0	25.0	25.0
L min.	24.0	24.0	24.0	24.0	24.0

\* Just for 182K

**Table of T & H1 max, A ± 0.8**

Diameter	5mm			7mm			10mm			14mm			20mm		
	T	A	H1	T	A	H1	T	A	H1	T	A	H1	T	A	H1
180M	4.5	0.8	10.5	4.5	0.8	12	4.9	0.8	15.5	5	0.9	19.5	---	---	---
220M/L	4.5	0.9	10.5	4.5	0.9	12	4.9	0.9	15.5	5	1	19.5	5.3	1	26.5
270M/K	4.7	0.9	10.5	4.7	0.9	12	5.1	0.9	15.5	5.2	1.1	19.5	5.4	1.1	26.5
330M/K	4.7	1	10.5	4.7	1	12	5.1	1	15.5	5.2	1.2	19.5	5.4	1.2	26.5
390L/K	4.7	1.2	10.5	4.7	1.2	12	5.1	1.2	15.5	5.2	1.4	19.5	5.4	1.4	26.5
470L/K	5	1.2	10.5	5	1.2	12	5.5	1.2	15.5	5.6	1.4	19.5	5.6	1.4	26.5
560L/K	5	1.4	10.5	5	1.4	12	5.5	1.4	15.5	5.6	1.6	19.5	5.6	1.6	26.5
680L/K	5.5	1.7	10.5	5.5	1.7	12	6	1.7	15.5	6.1	1.9	19.5	6.1	1.9	26.5
820K	3.8	0.8	10.5	3.8	0.8	12	4.3	0.8	15.5	4.4	1	19.5	5	1.1	26.5
101K	3.9	0.8	10.5	3.9	0.8	12	4.4	0.8	15.5	4.5	1	19.5	5.1	1.2	26.5
121K	4.1	0.9	10.5	4.1	0.9	12	4.5	0.9	15.5	4.6	1.1	19.5	5.3	1.3	26.5
151K	4.5	1.2	10.5	4.5	1.2	12	4.9	1.2	15.5	5.1	1.4	19.5	5.6	1.6	26.5
181K	4.1	1	10.5	4.1	1	12	4.5	1	15.5	4.7	1.2	19.5	5.2	1.4	26.5
201K	4.2	1	10.5	4.2	1	12	4.6	1	15.5	4.8	1.2	19.5	5.3	1.47	26.5
221K	4.3	1.1	10.5	4.3	1.1	12	4.7	1.1	15.5	4.9	1.3	19.5	5.4	1.5	26.5
241K	4.4	1.1	10.5	4.4	1.3	12	4.8	1.3	15.5	5	1.5	19.5	5.5	1.7	26.5
271K	4.6	1.3	10.5	4.6	1.4	12	5	1.4	15.5	5.2	1.5	19.5	5.7	1.9	26.5
301K	4.8	1.3	10.5	4.8	1.5	12	5.2	1.6	15.5	5.4	1.7	19.5	5.9	2.1	26.5
331K	4.9	1.3	10.5	4.9	1.5	12	5.3	1.6	15.5	5.5	1.7	19.5	6	2.1	26.5
361K	5.1	1.8	10.5	5.1	1.9	12	5.5	1.9	15.5	5.7	2.1	19.5	6.2	2.3	26.5
391K	5.3	2	11	5.3	2	12.5	5.7	2.2	16	5.9	2.2	20	6.4	2.4	26.5
431K	6.1	2.1	11	6.1	2	12.5	6.5	2.5	16	6.7	2.5	20	7.2	2.7	26.5
471K	6.4	2.2	11	6.4	2.3	12.5	6.8	2.6	16	7	2.7	20	7.5	2.9	27
511K	6.6	2.5	11.5	6.6	2.5	13	7	3.1	16.5	7.2	3.1	20.5	7.7	3.3	27
561K	6.9	2.8	11.5	6.9	2.8	13	7.3	3.4	16.5	7.5	3.4	20.5	8	3.6	27
621K	7.2	3.1	11.5	7.2	3.1	13	7.6	4	16.5	7.8	3.8	20.5	8.3	4.1	27
681K	7.5	3.4	11.5	7.5	3.4	13	8	4.4	16.5	8.2	4.1	20.5	8.7	4.4	27
751K	7.9	3.7	11.5	7.9	3.7	13	8.4	4.4	16.5	8.6	4.3	20.5	9.1	4.5	27
781K	---	---	---	8.1	3.9	13	8.6	4.6	16.5	8.8	4.6	20.5	9.3	4.8	27
821K	---	---	---	8.3	4.1	13	8.8	4.6	16.5	9	4.6	20.5	9.5	4.8	27
911K	---	---	---	---	---	---	9.4	5.4	16.5	9.6	5.4	20.5	10.1	5.7	27
102K	---	---	---	---	---	---	9.9	5.4	16.5	10.1	5.6	20.5	10.7	5.8	27
112K	---	---	---	---	---	---	10.5	5.7	16.5	10.7	6.1	20.5	11.2	6.3	27
122K	---	---	---	---	---	---	10.9	6.3	17	10.9	6.7	21	11.3	6.9	27.5
142K	---	---	---	---	---	---	11.9	7.4	17.5	11.9	7.8	21.5	12.8	8	28
162K	---	---	---	---	---	---	13.1	8.6	18	13.1	9	22	13.7	9.2	28.5
182K	---	---	---	---	---	---	14.3	9.8	18.5	14.3	10.2	22.5	14.7	10.4	29

■ TAPING SPECIFICATIONS

1/2" pitch

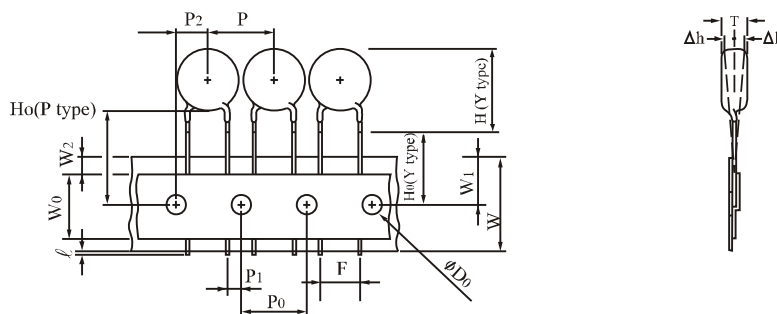

1.0" pitch

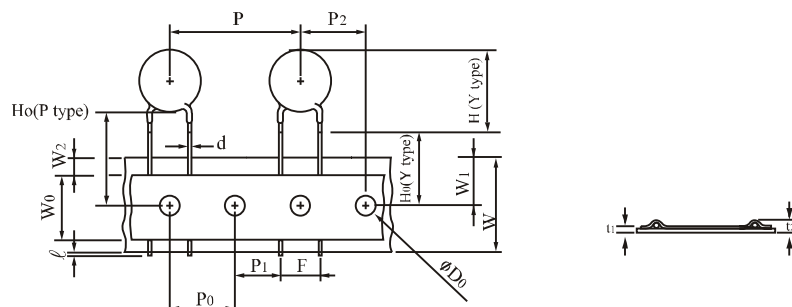

Symbols	Item	5 / 7 mm	10 / 14mm	20mm
	Cut out length	1.1 mm max.	1.1 mm max.	
H (Y Type)	Height of Top	See H Max. Table on page 4		
Ho (Y Type)	Height to seating plane	16.0 ± 0.5mm (*±1.0mm)	16.0 ± 0.5mm (*±1.0mm)	
Ho (P Type)	Height of component from hole center	16.0 ~ 21.0 mm	16.0 ~ 21.0 mm	
Δ h	Front to back deviation	0 ± 2.0 mm	0 ± 2.0 mm	
W	Carrier tape width	18.0 <sup>+1.0</sup> <sub>-0.5</sub> mm	18.0 <sup>+1.0</sup> <sub>-0.5</sub> mm	
W0	Hold down tape width	10.0mm	10.0mm	
W1	Sprocket hole position	9.0 <sup>+0.75</sup> <sub>-0.5</sub> mm	9.0 <sup>+0.75</sup> <sub>-0.5</sub> mm	
W2	Adhesive tape position	3.0 mm max.	3.0 mm max.	
F	Component head spacing	5.0 <sup>+0.8</sup> <sub>-0.2</sub> mm	7.5 <sup>+0.8</sup> <sub>-0.2</sub> mm	10 <sup>+0.8</sup> <sub>-0.2</sub> mm
P	Pitch of component	12.7 ± 1.0 mm	25.4 ± 1.0 mm	
P0	Sprocket hole pitch	12.7 ± 0.3 mm	12.7 ± 0.3 mm	
P1	Lead length from hole center to lead	3.85 ± 0.7 mm	8.95 ± 0.7 mm	7.7 ± 0.7 mm
P2	Length from hole center to disk center	6.35 ± 1.3 mm	12.7 ± 1.3 mm	
D0	Sprocket hole diameter	4.0 ± 0.2 mm	4.0 ± 0.2 mm	
d	Lead wire diameter	0.6 ± 0.05 mm	0.8 ± 0.05 mm	1.0 ± 0.05 mm
T	Disk thickness	See Table of T Max. on page 4		
t1	Total thickness tape	0.7 ± 0.05 mm	0.7 ± 0.05 mm	
t2	Total thickness	1.6 mm max.	1.8 mm max.	

\* for manual line

■ **PACKAGING**

in mm

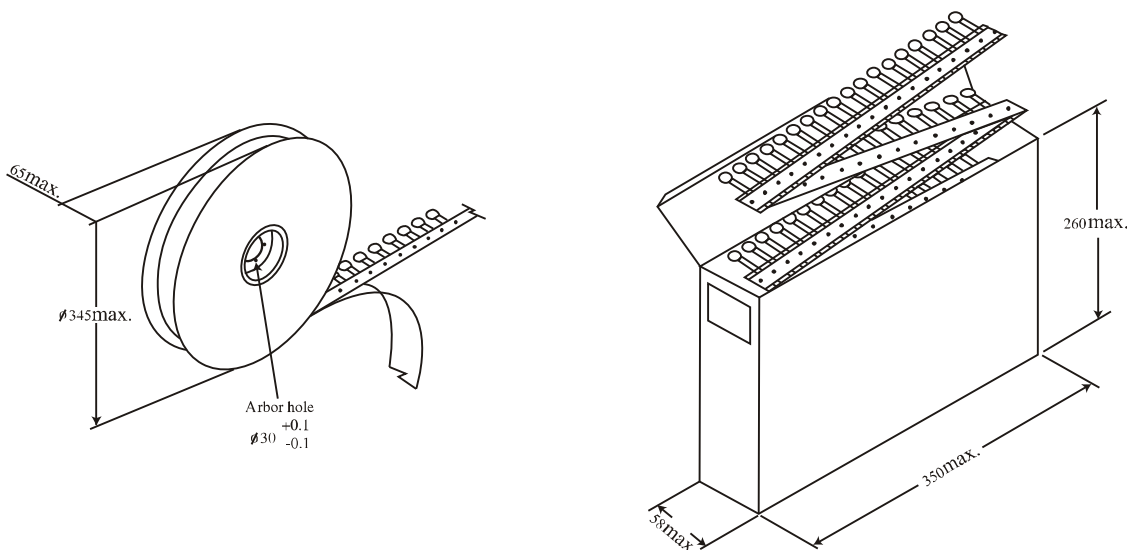

**Quantity per Packing Unit**

in Pcs

Series Part No.	5mm			7mm			10mm			14mm			20mm		
	Bulk (box)	Reel	Ammo	Bulk (box)	Reel	Ammo	Bulk (box)	Reel	Ammo	Bulk (box)	Reel	Ammo	Bulk (box)	Reel	Ammo
180M ~ 470K	5000	1500	1500	5000	1500	1500	2500	1000	500	1500	750	500	750	500	500
560K ~ 680K	5000	1500	1000	5000	1500	1000	2500	1000	500	1500	750	500	750	500	500
820K ~ 391K	5000	1500	1500	5000	1500	1500	2500	1000	500	1500	750	500	750	500	500
431K ~ 471K	5000	1500	1000	5000	1000	1000	2000	750	500	1500	750	500	750	500	500
511K ~ 821K	4000	1000	1000	4000	1000	1000	1500	500	500	750	500	500	450	500	500
911K ~ 122K	---	---	---	---	---	---	1500	500	350	750	500	350	450	---	---
142K ~ 182K	---	---	---	---	---	---	750	---	---	450	---	---	300	---	---

Packaging	Bulk (box)	Reel	Reel (14mm, 20mm)	Ammo (5mm, 7mm)	Ammo (10mm, 14mm)	Ammo (20mm)
Box size (mm)	290*155*110	350*350*105	346*346*72	335*245*43	347*246*50	348*255*60
Carton size (mm)	328*310*250	370*370*590	370*370*468	515*354*258	515*364*246	535*365*275
One carton with	4 boxes	5 boxes (10 reels)	6 boxes (6 reels)	10 boxes	8 boxes	8 boxes